

EQUINOX

Helix XP 150W

Gobo Flower

User Manual



Order codes:

EQLED200 - Black Housing

EQLED200A - White Housing

WARNING

FOR YOUR OWN SAFETY, PLEASE READ THIS USER MANUAL CAREFULLY BEFORE YOUR INITIAL START-UP!

- Before your initial start-up, please make sure that there is no damage caused during transportation.
- Should there be any damage, consult your dealer and do not use the equipment.
- To maintain the equipment in good working condition and to ensure safe operation, it is necessary for the user to follow the safety instructions and warning notes written in this manual.
- Please note that damages caused by user modifications to this equipment are not subject to warranty.



IMPORTANT:

The manufacturer will not accept liability for any resulting damages caused by the non-observance of this manual or any unauthorised modification to the equipment.

- Never let the power cable come into contact with other cables. Handle the power cable and all mains voltage connections with particular caution!
- Never remove warning or informative labels from the unit.
- Do not open the equipment and do not modify the unit.
- Do not connect this equipment to a dimmer pack.
- Do not switch the equipment on and off in short intervals, as this will reduce the system's life.
- Only use the equipment indoors.
- Do not sit the equipment on a flat surface as this can block the air intake to cool the LED.
- Do not expose to flammable sources, liquids or gases.
- Always disconnect the power from the mains when equipment is not in use or before cleaning! Only handle the power-cable by the plug. Never pull out the plug by pulling the power-cable.
- Make sure that the available mains supply voltage is between 100~240V AC, 50/60Hz.
- Make sure that the power cable is never crimped or damaged. Check the equipment and the power cable periodically.
- If the equipment is dropped or damaged, disconnect the mains power supply immediately and have a qualified engineer inspect the equipment before operating again.
- If the equipment has been exposed to drastic temperature fluctuation (e.g. after transportation), do not connect power or switch it on immediately. The arising condensation might damage the equipment. Leave the equipment switched off until it has reached room temperature.
- If your product fails to function correctly, stop use immediately. Pack the unit securely (preferably in the original packing material), and return it to your Pro Light dealer for service.
- Only use fuses of same type and rating.
- Repairs, servicing and power connection must only be carried out by a qualified technician. **THIS UNIT CONTAINS NO USER SERVICEABLE PARTS.**
- This lighting fixture is for professional use only - it is not designed for or suitable for household use. The product must be installed by a qualified technician in accordance with local territory regulations. The safety of the installation is the responsibility of the installer. The fixture presents risks of severe injury or death due to fire hazards, electric shock and falls.
- Warning! Risk Group 2 LED product according to EN 62471. Do not view the light output with optical instruments or any device that may concentrate the beam.
- **WARRANTY:** One year from date of purchase.

OPERATING DETERMINATIONS

If this equipment is operated in any other way, than those described in this manual, the product may suffer damage and the warranty becomes void. Incorrect operation may lead to danger e.g: short-circuit, burns and electric shocks etc.

Do not endanger your own safety and the safety of others!

Incorrect installation or use can cause serious damage to people and/or property.

Helix XP 150W Gobo Flower

The Helix XP is a powerful 150W LED gobo flower which produces an array of multi-coloured rotating gobos. All 8 gobos are interchangeable along with a separate colour wheel featuring 9 colours plus open. To further enhance this effect, an additional 11-piece gobo pack is also included to cover many popular events and celebrations. Clever programming allows users to select a single gobo and then have specific colours from the colour wheel added to them manually whilst being activated automatically or via sound. The unit, although compact in size, has a wide beam angle but still packs a punch over a long distance thanks to its superior optics and high output LED.

- 1 x 150W cool white LED (7200K)
- Beam angle: 42°
- Manual focus
- 8 rotating, replaceable gobos
- 9 colours + open
- DMX channels: 2/6 or 8 selectable
- Auto, sound active and master/slave modes plus built-in programs
- 0-100% dimming and variable strobe
- Supplied with dual position mounting bracket
- 4 push button menu with LED display
- Power input/output
- 3-Pin XLR input/output
- Fan cooled
- Supplied with an additional gobo pack containing 11 popular gobos

Specifications	
Power consumption	175W
Power supply	100~240V, 50/60Hz
Fuse	T3.15A 250V
Dimensions	205 x 370 x 273mm
Weight	4.8kg
Order code	EQLED200 - Black housing EQLED200A - White housing

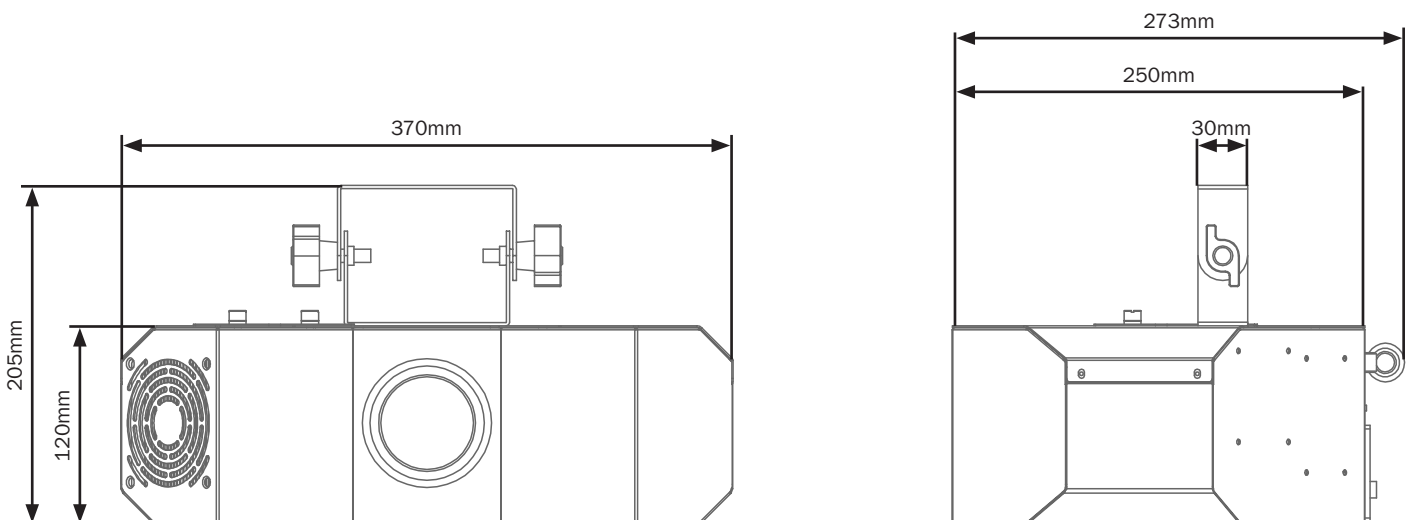

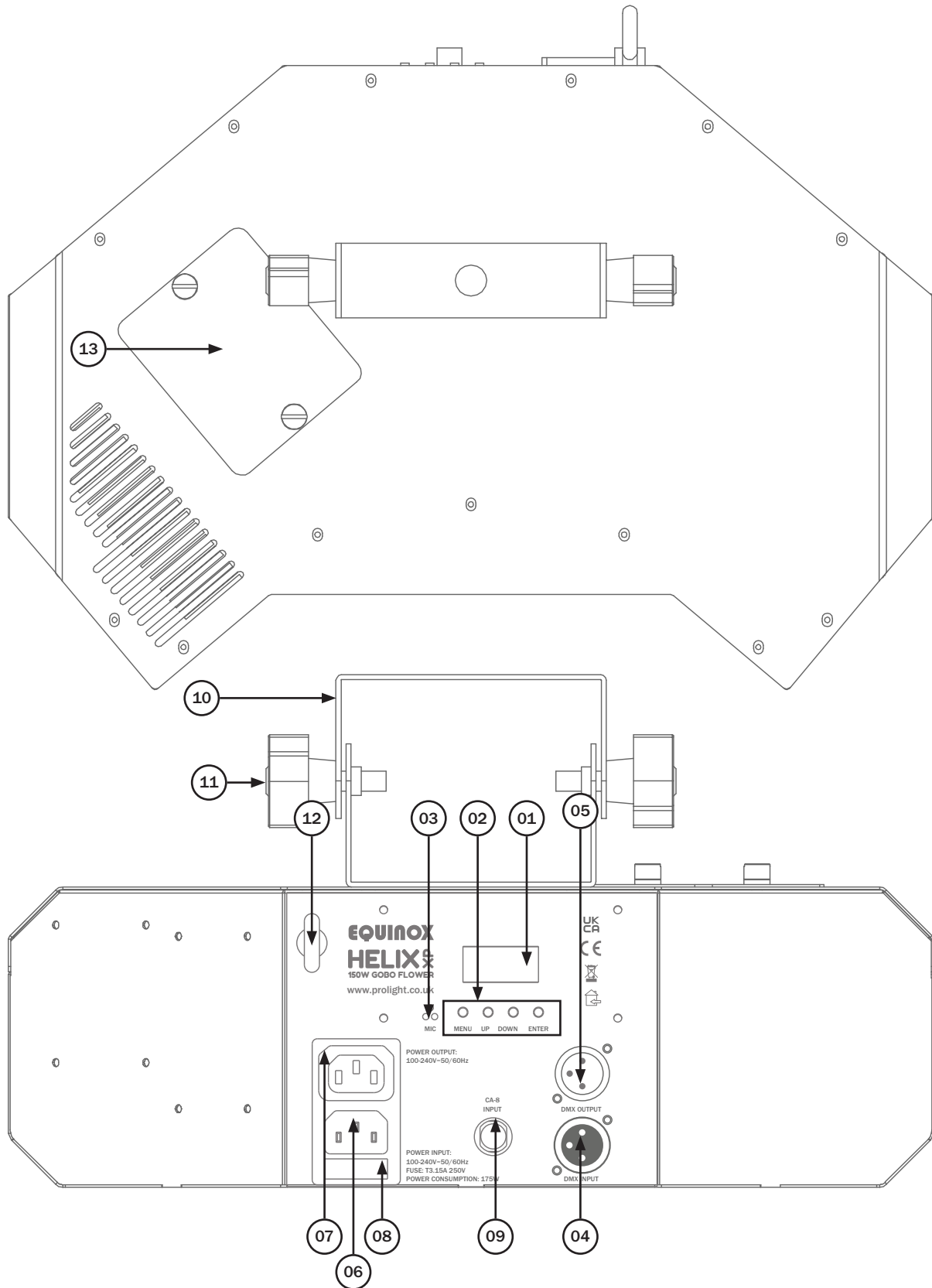

- 01 - LED display
- 02 - Function buttons
- 03 - Microphone
- 04 - 3-Pin DMX input
- 05 - 3-Pin DMX output

- 06 - IEC power input
- 07 - IEC power output
- 08 - Fuse T3.15A 250V
- 09 - CA8 control input
- 10 - Hanging bracket

- 11 - Hanging bracket adjustment knobs
- 12 - Safety eye
- 13 - Gobo access slot

In the box: **1 x fixture,**
1 x power cable,
1 x gobo pack
& 1 x user manual

Rotating Gobo Replacement:

The fixture is supplied with 8 rotating, replaceable gobos. See below for installation instructions.

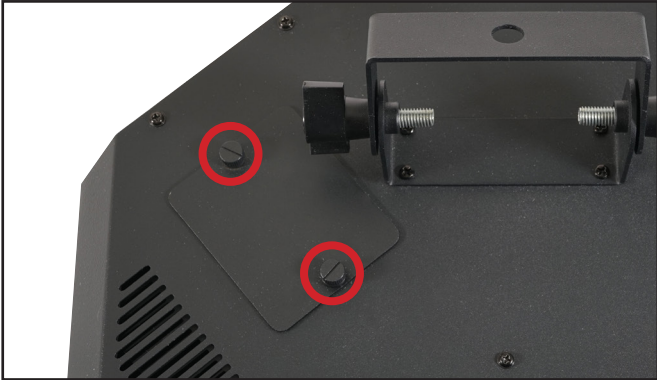

1) Disconnect and isolate from power and wait for the unit to cool, place the fixture on a flat surface and unscrew the thumbscrews on the gobo access door.

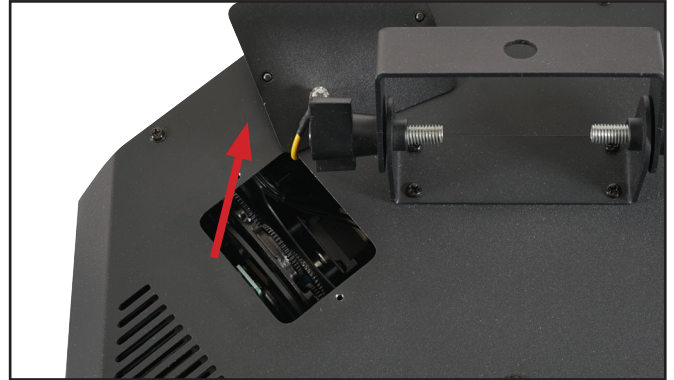

2) Remove the gobo access door (this is connected to the main chassis with an earth wire, do not disconnect this).



3) Carefully push the gobo holder you are wanting to replace away from the gobo wheel.



4) Pull the gobo holder up out of the unit. Now you can remove the circlip, followed by the gobo from the gobo tray. Replace the gobo and fit the circlip back into the tray.



5) Push the gobo holder back into the slot in the gobo wheel and push towards to gobo wheel to ensure it is seated correctly.

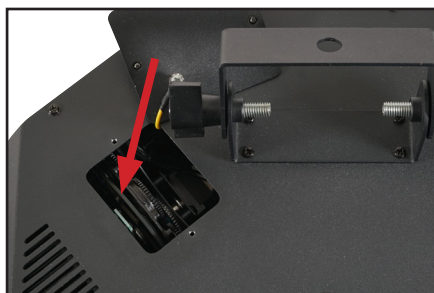

6) Move the gobo access door back into position over the gobo access slot.

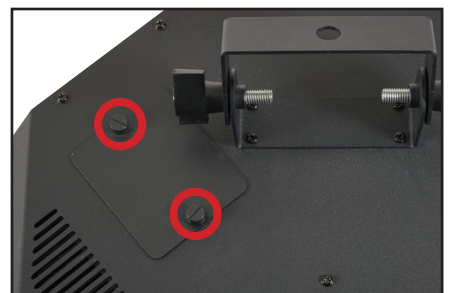

7) Tighten both thumbscrews to secure the gobo access door.

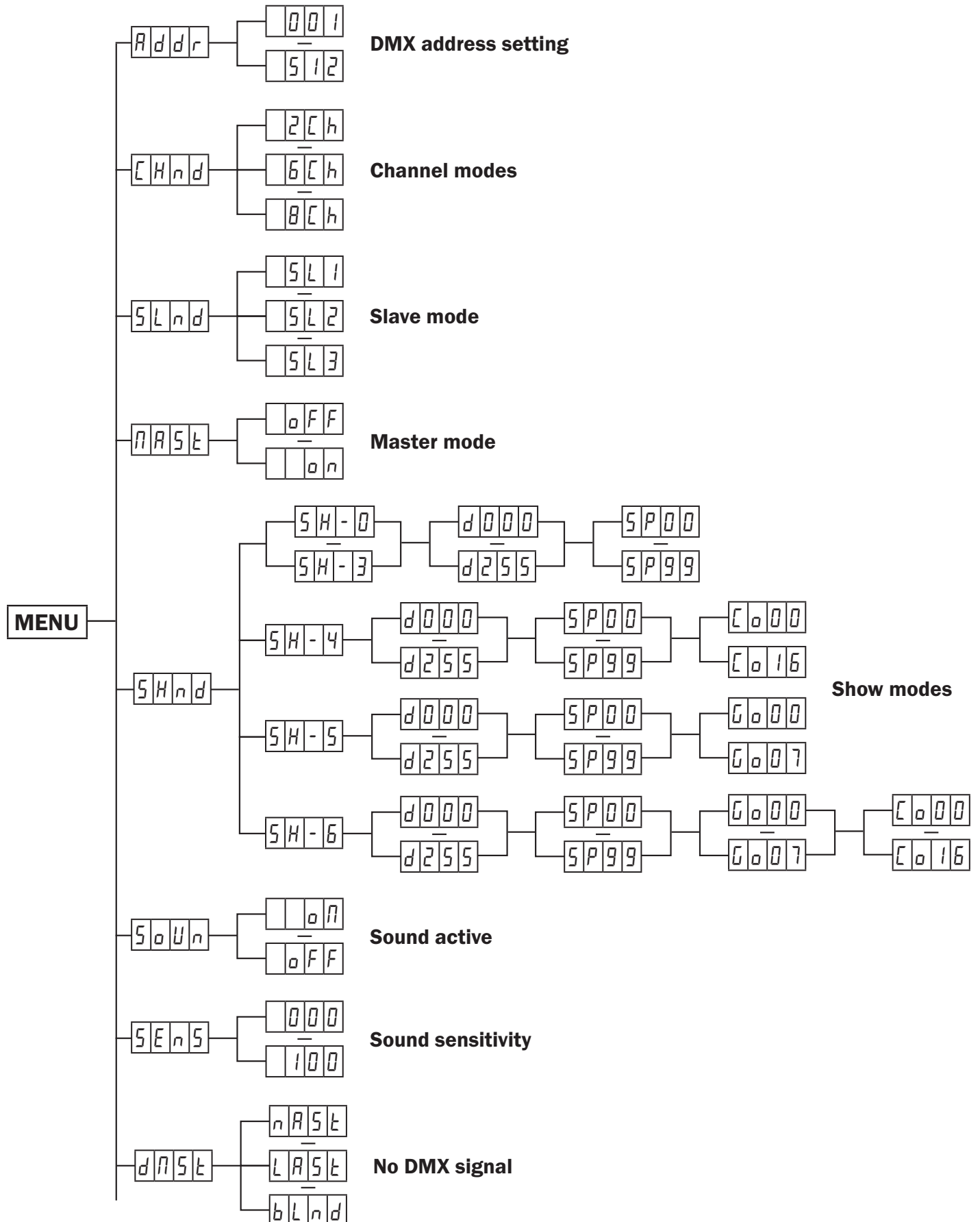

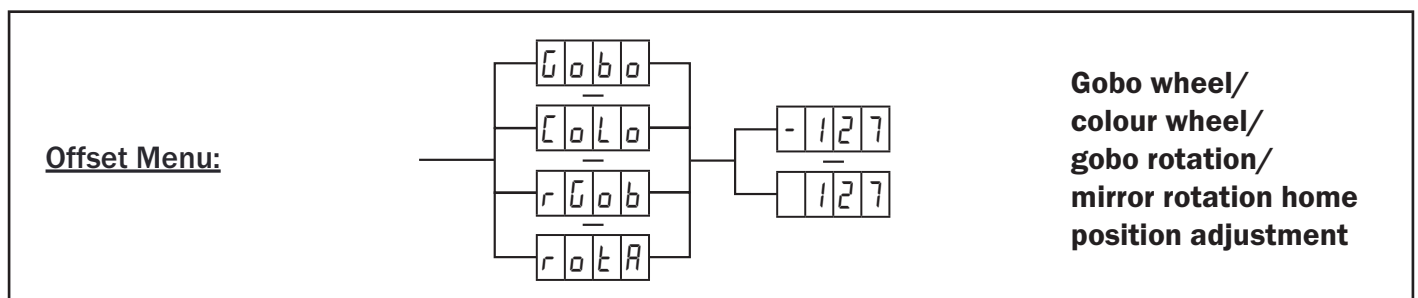
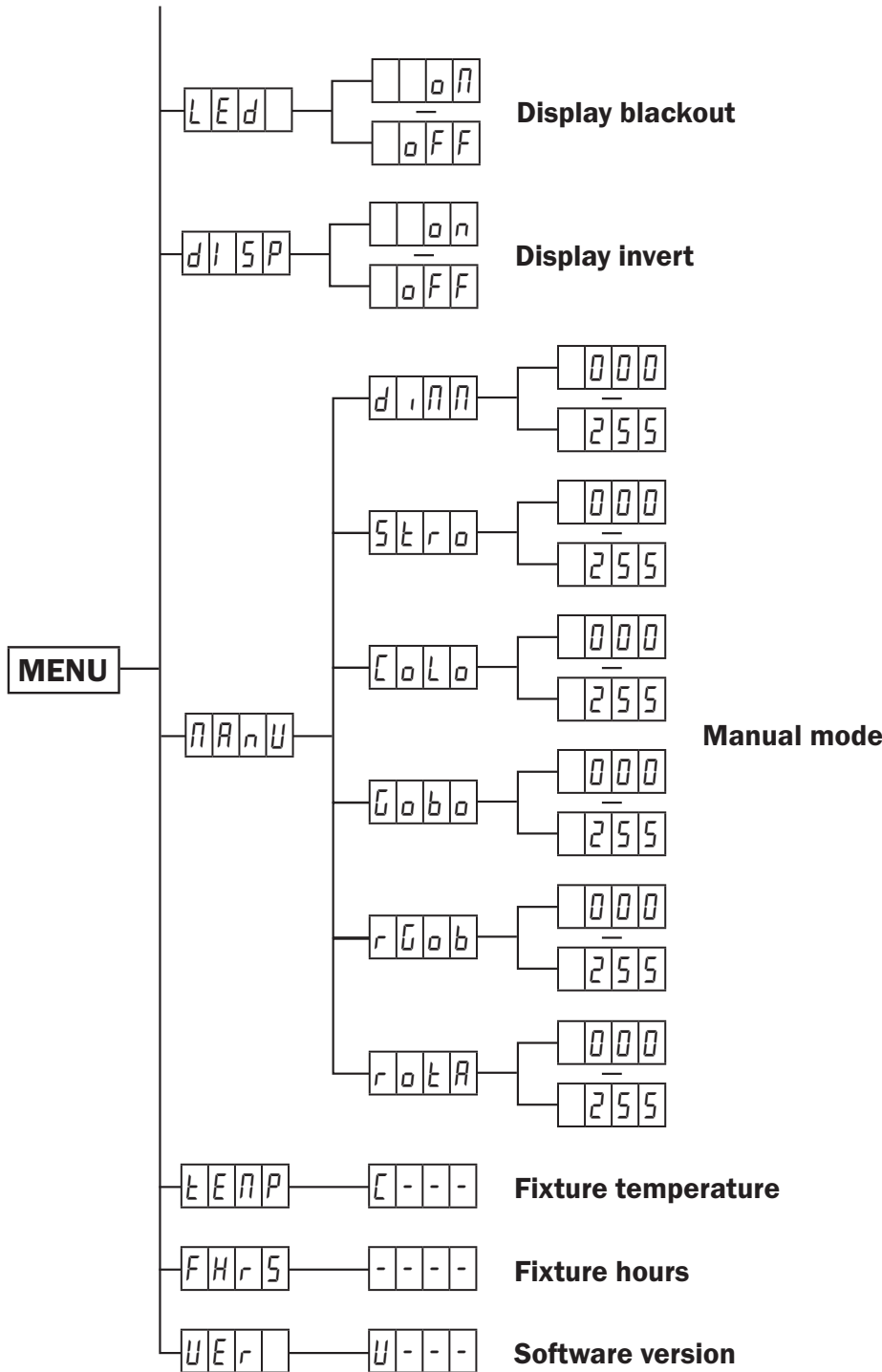

DMX mode:

Operating in a DMX control mode environment gives the user the greatest flexibility when it comes to customising or creating a show. In this mode you will be able to control each individual trait of the fixture and each fixture independently.

To access the DMX address mode, press the “**MENU**” button and use the “**UP**” and “**DOWN**” buttons on the rear of the unit to show *Addr* on the LED display. Now press the “**ENTER**” button and use the “**UP**” and “**DOWN**” buttons to set the required DMX address. Press the “**ENTER**” button to confirm the setting. To exit out of any of the above options, press the “**MENU**” button.

DMX channel mode:

To access the DMX channel mode, press the “**MENU**” button and use the “**UP**” and “**DOWN**” buttons on the rear of the unit to show *Chnd* on the LED display. Now press the “**ENTER**” button and use the “**UP**” and “**DOWN**” buttons to choose one of the 2/6 or 8 DMX channel modes. Press the “**ENTER**” button to confirm the setting. To exit out of any of the above options, press the “**MENU**” button.

2 channel mode:

Channel	Value	Function
CH1	000-012	Blackout
	013-045	Show 0 (All shows)
	046-080	Show 1 (All gobos & colours inc. split colours)
	081-115	Show 2 (Slow mode non-reactive to sound/speed setting)
	116-150	Show 3 (All gobos & colours exc. split colours)
	151-185	Show 4 (All gobos, colour selected via menu)
	186-220	Show 5 (All colours, gobo selected via menu)
	221-255	Show 6 (Colour and gobo selected via menu)
CH2	000-255	Show mode motor speed (slow-fast)

*Please note: The dimmer setting in the show modes via the menu takes priority over DMX, this should be set at 255 to be fully controlled via DMX.

The show mode motor speed is only controllable when Sound Active mode is set to OFF in the menu.

6 channel mode:

Channel	Value	Function
CH1	000-255	Master dimmer (0-100%)
CH2	000-031	Blackout
	032-063	Open
	064-095	Strobe (slow-fast)
	096-127	Open
	128-159	Pulse (slow-fast)
	160-191	Open
	192-223	Random strobe (slow-fast)
	224-255	Open
CH3	000-015	Open
	016-022	Red
	023-029	Red/Blue
	030-036	Blue
	037-043	Blue/Magenta
	044-050	Magenta
	051-057	Magenta/Yellow
	058-064	Yellow
	065-071	Yellow/Green
	072-078	Green
	079-085	Green/Orange
	086-092	Orange
	093-099	Orange/Cyan
	100-106	Cyan
	107-113	Cyan/Purple
	114-120	Purple
	121-127	3200K
	128-191	Colour scroll clockwise (fast-slow)
192-255	Colour scroll anti-clockwise (slow-fast)	
CH4	000-016	Gobo 1
	017-033	Gobo 2
	034-050	Gobo 3
	051-067	Gobo 4
	068-084	Gobo 5
	085-101	Gobo 6
	102-118	Gobo 7
	119-135	Gobo 8
	136-195	Gobo scroll clockwise (fast-slow)
	196-255	Gobo scroll anti-clockwise (slow-fast)

Channel	Value	Function
CH5	000-127	Gobo rotation index
	128-191	Gobo clockwise rotation (fast-slow)
	192-255	Gobo anti-clockwise rotation (fast-slow)
CH6	000-127	Mirror dish rotation index
	128-191	Mirror dish anti-clockwise rotation (fast-slow)
	192-255	Mirror dish clockwise rotation (fast-slow)

8 channel mode:

Channel	Value	Function
CH1	000-255	Master dimmer (0-100%)
CH2	000-031	Blackout
	032-063	Open
	064-095	Strobe (slow-fast)
	096-127	Open
	128-159	Pulse (slow-fast)
	160-191	Open
	192-223	Random strobe (slow-fast)
	224-255	Open
CH3	000-015	Open
	016-022	Red
	023-029	Red/Blue
	030-036	Blue
	037-043	Blue/Magenta
	044-050	Magenta
	051-057	Magenta/Yellow
	058-064	Yellow
	065-071	Yellow/Green
	072-078	Green
	079-085	Green/Orange
	086-092	Orange
	093-099	Orange/Cyan
	100-106	Cyan
	107-113	Cyan/Purple
	114-120	Purple
	121-127	3200K
	128-191	Colour scroll clockwise (fast-slow)
192-255	Colour scroll anti-clockwise (slow-fast)	
CH4	000-016	Gobo 1
	017-033	Gobo 2
	034-050	Gobo 3
	051-067	Gobo 4
	068-084	Gobo 5
	085-101	Gobo 6
	102-118	Gobo 7
	119-135	Gobo 8
	136-195	Gobo scroll clockwise (fast-slow)
	196-255	Gobo scroll anti-clockwise (slow-fast)

Channel	Value	Function
CH5	000-127	Gobo rotation index
	128-191	Gobo clockwise rotation (fast-slow)
	192-255	Gobo anti-clockwise rotation (fast-slow)
CH6	000-127	Mirror dish rotation index
	128-191	Mirror dish anti-clockwise rotation (fast-slow)
	192-255	Mirror dish clockwise rotation (fast-slow)
CH7	000-012	No function
	013-045	Show 0 (All shows)
	046-080	Show 1 (All gobos & colours inc. split colours)
	081-115	Show 2 (Slow mode non-reactive to sound/speed setting)
	116-150	Show 3 (All gobos & colours exc. split colours)
	151-185	Show 4 (All gobos, colour selected via menu)
	186-220	Show 5 (All colours, gobo selected via menu)
221-255	Show 6 (Colour and gobo selected via menu)	
CH8	000-255	Show mode motor speed (slow-fast)

*Please note: The dimmer setting in the show modes via the menu takes priority over DMX, this should be set at 255 to be fully controlled via DMX.

The show mode motor speed is only controllable when Sound Active mode is set to OFF in the menu.

Master/slave mode:

To set the master unit, press the “MENU” button and use the “UP” and “DOWN” buttons on the rear of the unit to show *MASTER* on the LED display. Now press the “ENTER” button and use the “UP” and “DOWN” buttons to choose *ON* choose *OFF*. Press the “ENTER” button to confirm the setting.

Then select your desired program.

To set the other units in slave mode, press the “MENU” button and use the “UP” and “DOWN” buttons on the rear of the unit to show *SLAVE* on the LED display. Now press the “ENTER” button and use the “UP” and “DOWN” buttons to choose either *SL 1* (copies master), *SL 2* (opposite mirror dish rotation direction to master) or *SL 3* (opposite mirror dish rotation direction and colour to master).

Press the “ENTER” button to confirm the setting. The unit will now run in sequence with the master unit.

To exit out of any of the above options, press the “MENU” button.

Please ensure that all slave units are set to the same DMX channel mode as the master unit.

Show mode:

To access the show modes, press the “MENU” button and use the “UP” and “DOWN” buttons on the rear of the unit to show *SHOW* on the LED display. Now press the “ENTER” button and use the “UP” and “DOWN” buttons to choose between *SH-0* ~ *SH-6*. Now press the “ENTER” button and use the “UP” and “DOWN” buttons to select the brightness between *d000* ~ *d255*. Now press the “ENTER” button and use the “UP” and “DOWN” buttons to select the speed between *SP00* ~ *SP99*.

In Show 4 you can set a specific colour with all gobos. Press the “ENTER” button again and use the “UP” and “DOWN” buttons to select the colour between *C000* ~ *C016*.

In Show 5 you can set a specific gobo with all colours. Press the “ENTER” button again and use the “UP” and “DOWN” buttons to select the gobo between *G000* ~ *G007*.

In Show 6 you can set a specific colour with a specific gobos. Press the “ENTER” button again and use the “UP” and “DOWN” buttons to select the gobo between *G000* ~ *G007*. Press the “ENTER” button once more and use the “UP” and “DOWN” buttons to select the colour between *C000* ~ *C016*.

Press the “ENTER” button to confirm the setting. To exit out of any of the above options, press the “MENU” button.

*Please note: The dimmer setting in the show modes via the menu takes priority over DMX, this should be set at 255 to be fully controlled via DMX.

Show 0	Show 0 (All shows)
Show 1	Show 1 (All gobos & colours inc. split colours)
Show 2	Show 2 (Slow mode non-reactive to sound)
Show 3	Show 3 (All gobos & colours exc. split colours)

Show 4	Show 4 (All gobos, colour selected via menu)
Show 5	Show 5 (All colours, gobo selected via menu)
Show 6	Show 6 (Colour and gobo selected via menu)

Sound active:

To access the sound active setting, press the “MENU” button and use the “UP” and “DOWN” buttons on the rear of the unit to show *SOUND* on the LED display. Now press the “ENTER” button and use the “UP” and “DOWN” buttons to choose between *ON* or *OFF*. Press the “ENTER” button to confirm the setting. To exit out of any of the above options, press the “MENU” button.

Sound sensitivity:

To adjust the sound sensitivity, press the “MENU” button and use the “UP” and “DOWN” buttons on the rear of the unit to show *SEnS* on the LED display. Now press the “ENTER” button and use the “UP” and “DOWN” buttons to choose between *000 ~ 100*. Press the “ENTER” button to confirm the setting.
Value: 0 - 100 (0 = low, 100 = high)

To exit out of any of the above options, press the “MENU” button.

DMX signal lost:

To change what the unit does when the DMX signal is lost, press the “MENU” button and use the “UP” and “DOWN” buttons on the rear of the unit to show *dmSt* on the LED display. Now press the “ENTER” button and use the “UP” and “DOWN” buttons to choose between *nASL* (Master/Slave), *LASL* (Hold the last DMX command) or *BLnd* (Blackout).

Press the “ENTER” button to confirm the setting.

To exit out of any of the above options, press the “MENU” button.

Display blackout:

To access the display blackout setting, press the “MENU” button and use the “UP” and “DOWN” buttons on the rear of the unit to show *LEd* on the LED display. Now press the “ENTER” button and use the “UP” and “DOWN” buttons to choose between *on* (display blacks out) or *oFF* (display always on). Press the “ENTER” button to confirm the setting. To exit out of any of the above options, press the “MENU” button.

Display invert setting:

To access the display invert setting, press the “MENU” button and use the “UP” and “DOWN” buttons on the rear of the unit to show *di SP* on the LED display. Now press the “ENTER” button and use the “UP” and “DOWN” buttons to choose between *on* or *oFF*. Press the “ENTER” button to confirm the setting. To exit out of any of the above options, press the “MENU” button.

Manual mode:

To access manual mode, press the “MENU” button on the front of the unit to show *MANU* on the LED display. Now press the “ENTER” button and use the “UP” and “DOWN” buttons to choose between *d i n n* (Dimmer), *Stro* (Strobe), *CoLo* (Colour), *Gob* (Gobo), *r Gob* (Gobo Rotation) or *r OtA* (Mirror Rotation). Press the “ENTER” button and use the “UP” and “DOWN” buttons to choose between *000 ~ 255*. Press the “ENTER” button to confirm the setting.

To exit out of any of the above options, press the “MENU” button.

Fixture temperature:

To access the fixtures temperature, press the “MENU” button and use the “UP” and “DOWN” buttons on the rear of the unit to show *TEMP* on the LED display. Now press the “ENTER” button.

The unit will now display the fixtures temperature.

To exit out of any of the above options, press the “MENU” button.

Fixture hours:

To access the fixtures usage time, press the “MENU” button and use the “UP” and “DOWN” buttons on the rear of the unit to show *FHR 5* on the LED display. Now press the “ENTER” button.

The unit will now display the fixtures usage time (hours).

To exit out of any of the above options, press the “MENU” button.

Software version:

To access the fixtures software version, press the “MENU” button and use the “UP” and “DOWN” buttons on the rear of the unit to show *VER* on the LED display. Now press the “ENTER” button.

The unit will now display the fixtures software version.

To exit out of any of the above options, press the “MENU” button.

Gobo/colour wheel home position adjustment:

To access the offset menu for the gobo, colour, gobo rotation and mirror rotation home position adjustment settings, press the “MENU” button once and hold the “ENTER” button for 3 seconds to display *COL* on the LED display. Now use the “UP” and “DOWN” buttons to choose between *Gobo* (Gobo), *COL* (Colour), *r Gob* (Gobo Rotation) or *r R A* (Mirror Rotation).

Press the “ENTER” button and use the “UP” and “DOWN” buttons to set the required gobo wheel home position between *- 127 ~ 127*. Press the “ENTER” button to confirm the setting.

CA 8 function:

The unit has a CA 8 remote control input on the rear. This may be used with the CA 8 hand controller (sold separately) to control the unit. Please see functions below.

Blackout - By pressing the Stand By button the fixture will blackout.

Mode - Use this button to put the fixture into auto, show or motor speed modes.

Auto mode (Show 0) - LED off

Motor speed (1-9) - LED on

Show modes (Shows 1-6) - LED flashing

Function - Once you have chosen the mode you require use this button to set the motor speed or show mode.

Motor speed (1-9)

Show modes (Shows 1-6)

Setting the DMX address:

The DMX mode enables the use of a universal DMX controller. Each fixture requires a “start address” from 1- 512. A fixture requiring one or more channels for control begins to read the data on the channel indicated by the start address. For example, a fixture that occupies or uses 7 channels of DMX and was addressed to start on DMX channel 100, would read data from channels: 100, 101, 102, 103, 104, 105 and 106. Choose a start address so that the channels used do not overlap. E.g. the next unit in the chain starts at 107.

DMX 512:

DMX (Digital Multiplex) is a universal protocol used as a form of communication between intelligent fixtures and controllers. A DMX controller sends DMX data instructions from the controller to the fixture. DMX data is sent as serial data that travels from fixture to fixture via the DATA “IN” and DATA “OUT” XLR terminals located on all DMX fixtures (most controllers only have a data “out” terminal).

DMX linking:

DMX is a language allowing all makes and models of different manufactures to be linked together and operate from a single controller, as long as all fixtures and the controller are DMX compliant. To ensure proper DMX data transmission, when using several DMX fixtures try to use the shortest cable path possible. The order in which fixtures are connected in a DMX line does not influence the DMX addressing. For example; a fixture assigned to a DMX address of 1 may be placed anywhere in a DMX line, at the beginning, at the end, or anywhere in the middle. When a fixture is assigned a DMX address of 1, the DMX controller knows to send DATA assigned to address 1 to that unit, no matter where it is located in the DMX chain.

DATA cable (DMX cable) requirements (for DMX operation):

This fixture can be controlled via DMX-512 protocol. The DMX address is set on the back of the unit. Your unit requires either a standard 3-pin or 5-pin XLR connector for data input/output, see images below.



Further DMX cables can be purchased from all good sound and lighting suppliers or Prolight Concepts dealers.

Please quote:	3-Pin:	CABL10 – 2m	CABL11 – 5m	CABL12 – 10m
	5-Pin:	CABL185 – 2m	CABL187 – 5m	CABL188 – 10m

Also remember that DMX cable must be daisy chained and cannot be split.

Notice:

Be sure to follow the diagrams below when making your own cables. Do not connect the cables shield conductor to the ground lug or allow the shield conductor to come in contact with the XLRs outer casing. Grounding the shield could cause a short circuit and erratic behaviour.

Pin Configuration	
3-Pin	5-Pin
	Pin 1 - Ground
	Pin 2 - Negative
	Pin 3 - Positive
-	Pin 4 - N/C
-	Pin 5 - N/C

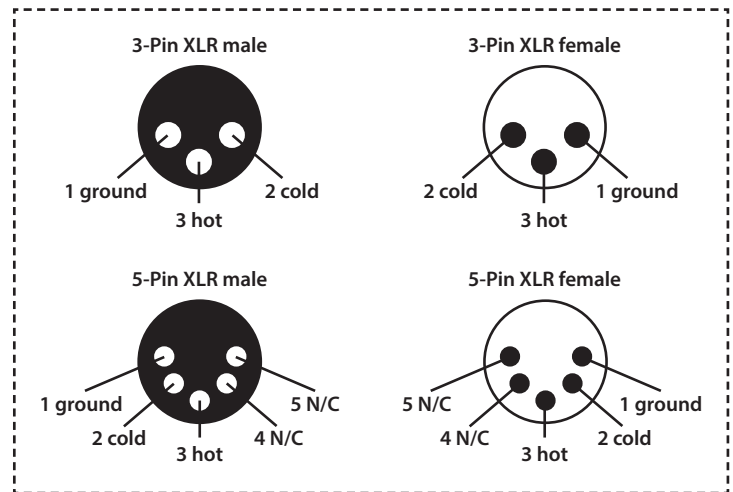
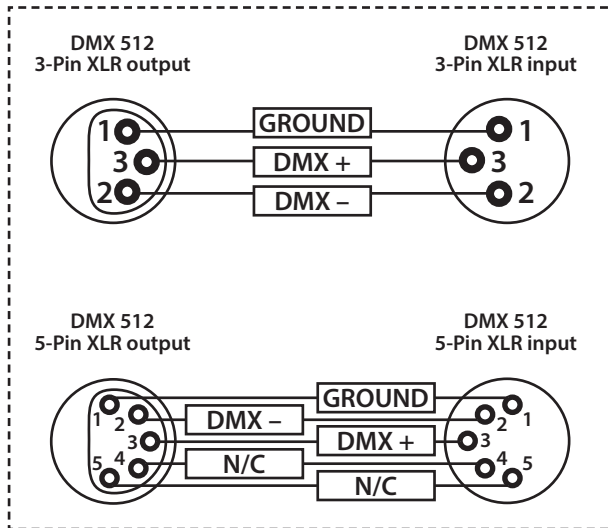

Line termination:

When longer runs of cable are used, you may need to use a terminator on the last unit to avoid erratic behaviour.

Using a cable terminator will decrease the possibilities of erratic behaviour.

(3-pin - Order ref: CABL90,
5-pin - Order ref: CABL89)

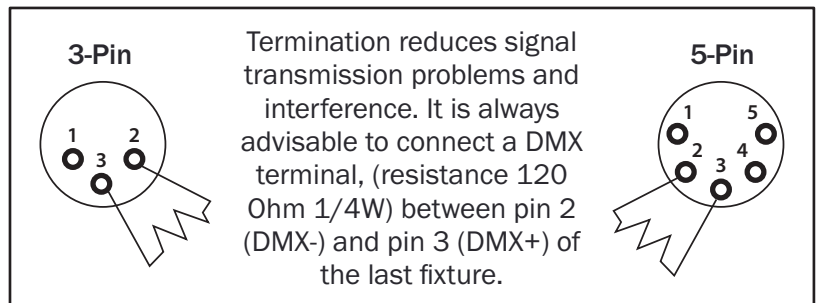

5-pin XLR DMX connectors:

Some manufactures use 5-pin XLR connectors for data transmission in place of 3-pin. 5-pin XLR fixtures may be implemented in a 3-pin XLR DMX line. When inserting standard 5-pin XLR connectors in to a 3-pin line a cable adaptor must be used. The diagram below details the correct cable conversion.

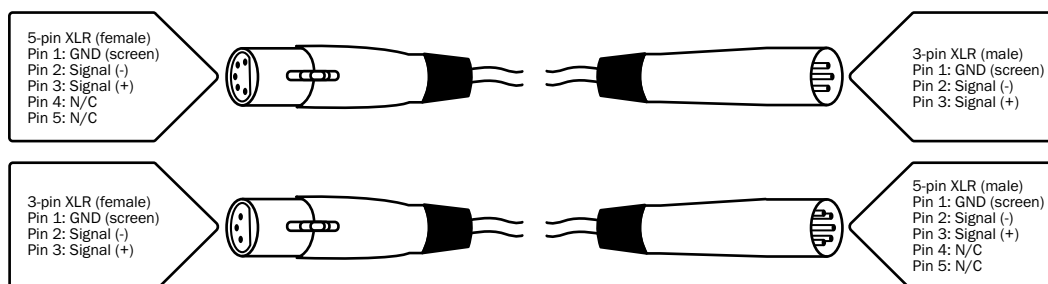

Power linking:

This fixture provides power linking via the power output on the rear allowing multiple units to be connected together. The maximum number of fixtures that can be connected is 12 fixtures @ 240V or 6 fixtures @ 120V (including the first fixture). After the maximum number of fixtures are connected a new power run will need to be started.

Please note: Caution should be used when power linking other fixtures to the Helix XP 150W Gobo Flower as the power consumption of other fixtures will vary. Fixtures fitted with lamps often require 2/3 times more current on startup, these may require their own power source.

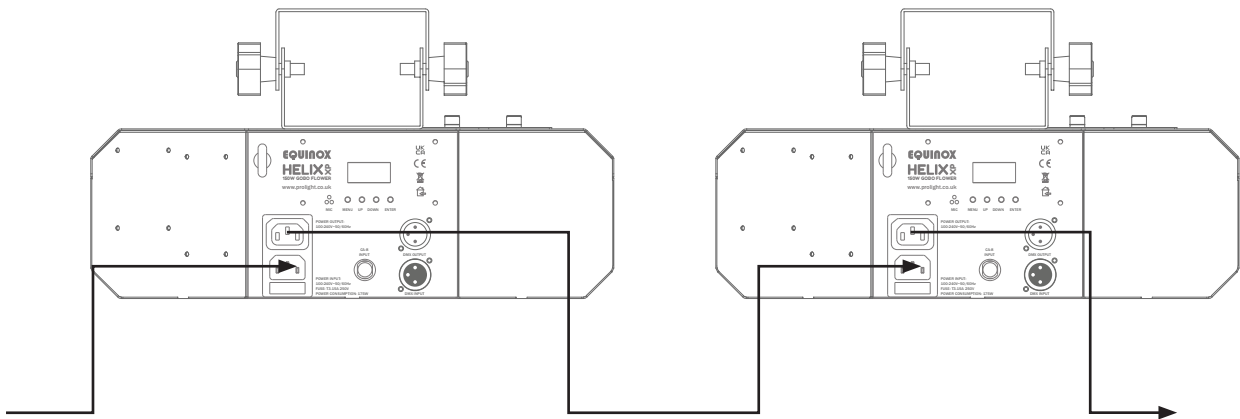



Correct Disposal of this Product (Waste Electrical & Electronic Equipment)

**(Applicable in the European Union and other European countries
with separate collection systems)**

This marking shown on the product or its literature, indicates that it should not be disposed of with other household wastes at the end of its working life. To prevent possible harm to the environment or human health from uncontrolled waste disposal, please separate this from other types of wastes and recycle it responsibly to promote the sustainable reuse of material resources.

Household users should contact either the retailer where they purchased this product, or their local government office, for details of where and how they can take this item for environmentally safe recycling.

Business users should contact their supplier and check the terms and conditions of the purchase contract. This product should not be mixed with other commercial wastes for disposal.



EQUINOX