

# TOUCH 512/1024

Wall mounted DMX Lighting Controller

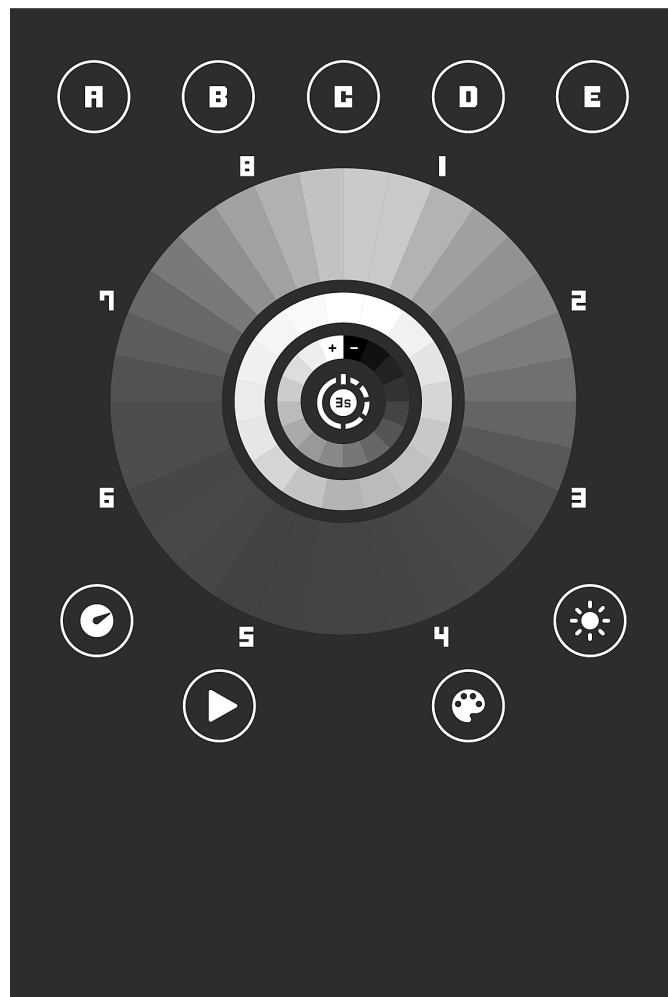

Datasheet &  
Quickstart Guide

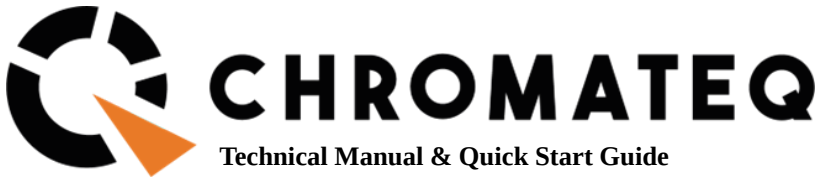

Congratulations on your purchase of a CHROMATEQ controller.

Please read this manual carefully and thoroughly before using the TOUCH Chromateq.

The information presented here provides a useful introduction to the wide range of features, settings and functions available in this compact and versatile TOUCH

The TOUCH Technical Manual is written in English and French.  
(Le manuel technique du TOUCH est rédigé en anglais et en français.)

All products and software are developed and designed in France.

CHROMATEQ SARL

191 Allée de Lauzard 34980 St Gély du Fesc FRANCE VAT: FR18521458034 Siret: 52145803400027 Web & E-mail:  
www.chromateq.com Phone: +33 952210755 / +86 13422062209 Whatsapp: +8613422062209 Wechat: Chromateq QQ:  
2908265661

Twitter: <https://twitter.com/Chromateq>  
Facebook: <https://www.facebook.com/ChromateqCompany/>  
YouTube: <https://www.youtube.com/c/chromateq>

-----  
**Copyright Information and Disclaimer**

Copyright © 2021 - CHROMATEQ. All rights reserved.

No part of this publication may be reproduced, distributed or transmitted in any form or by any means whatsoever, including photocopying, recording or other electronic or mechanical methods, without the prior written permission of the publisher, except in the case of brief quotations in criticisms and certain other non-commercial uses permitted by copyright law.

For any request for authorization, write to the publisher at the address above.

**Trademark credits**

Microsoft and Windows are U.S. registered trademarks of Microsoft Corporations. Art-Net™ - Designed by and Copyright Artistic License Holdings Ltd. All other products mentioned herein may be trademarks of their respective ® companies.

**Package Contents**

- 1x TOUCH
- 1x USB cable
- 1x Power supply 9-12V DC - Optional (Euro/US socket)
- 1x software download link and technical documentation

**Caution: Check the contents of the package and the condition of the interface after unpacking! Contact your supplier if something is missing or is damaged. Do not use the device if it appears to be damaged!**

## Table des matières

Introduction.....	5
Technical .....	5
Device features .....	5
Software option.....	6
Connectors and operation panel .....	7
Rear panel &.....	7
Operation panel.....	8
USB drivers installation .....	9
Multiple USB connections.....	9
Standalone mode settings .....	10
Device configuration .....	10
IN/OUT tab .....	10
"Merge DMX In / DMX Out" option.....	11
Art-Net/sACN universe range:.....	11
Clock tab.....	12
Options tab .....	12
Master/Slave tab.....	13
Master/Slave mode "by default".....	14
Commands tab.....	15
Zones tab .....	15
Configuring the standalone modes of the device.....	16
Scenes selection and configuration .....	18
Choice of triggers.....	18
Triggers by buttons in the "Device" tab.....	18
External contacts Trigger:.....	19
Triggers by DMX-IN.....	20
Time triggers.....	21
Single trigger.....	21
Permanent trigger.....	21
Light intensity trigger .....	22
Priority of hourly trigger.....	22
Advanced trigger options. ....	22
Restore after power off.....	23
Play in priority.....	23
Save in memory option.....	23
Basic backup.....	24
Save to an internal and external micro SD card.....	24
Backing up Art-Net or sACN to an external SD card .....	24
Standalone use.....	25
Switch to standalone mode.....	25
External and USB power supply.....	25
Charging the clock battery.....	25

Play a show via a Micro SD Card.....	25
Dimensions and mounting.....	27
Troubleshooting .....	28

## Introduction

This touch panel is compatible with all the manufacturer's software, it can be integrated into scalable control systems designed for fixed indoor installations, or deployed individually without a computer as a standalone, elegant, simple but sophisticated control solution.

The SD card offers the ability to expand memory capacity, DMX splitter mode enhances the reliability of DMX networks.

### Objectives

The purpose of this technical manual is to develop the options managed by the device in standalone mode, for software options, please refer to the software manuals.

## Technical features

Connectors	USB-C, Screw terminal and RJ45 (External contact, Master/Slave, Infrared, Light Sensor)
DMX lines	2 x 512 channels 8 and 16-bit DMX channels
Internal memory	yes, 4MB (no SD card required)
Internal memory capacity	20000 steps with 16 hp., 6000 steps with 512 hp., 3000 steps with 1024 hp.
External memory	Micro SD card (accepts FAT, FAT 32, Class 10 SD card up to 256 GB)
CPU	32-bit processor
Power supply	5V to 24V DC, 0.2A/5V via USB-C
Power / Consumption	0.3 ~ 0.5 W
IP rating	IP40
Dimensions (mm)	H: 144 (5.67 in ) / L: 97 (3.82 in) / I: 10 (0.39 in)
Net weight (device)	0.2 Kgs (0.44 lbs)
Gross weight (full cost)	0.3 Kgs (0.66 lbs)
High voltage protection	Yes, fuses and diodes
Case	ABS glass panel
Environment of use	Interior
Storage	Store dry
Temperature of use	- 40 to +85 C°
Certifications	CE, RoHS
International guarantee	Yes, 5 years
Compatibility of systems	Windows (7 and higher), MAC OS X (10.13 and higher) and Linux (64 Bits, Debian, Redhat, Archlinux, Raspberry Pi)

## Device features

DMX 512 mode	2x512 output (Splitter, PC + Autonomous) or 512 output and 512 in input (PC only, DMX recording, DMX trigger, DMX merge)
DMX 1024	2x512 output, 1024 in output or 512 output and 512 in input (PC and standalone mode, DMX recording, DMX trigger, DMX merge)
Multiple zones (DMX 1024 mode only)	5 zones, plays up to 5 scenes simultaneously
Combined areas (DMX 1024 mode only)	yes
Clock in real time - RTC	Time and calendar triggering
Touch buttons	8 scenes, 5 zones (1024), 4 modes, 1 on/off
Touch control wheel	yes (color, CTC, dimmer intensity, speed, scenes)
External contacts	4 (15 maximum)
Master/Slave synchro	Yes, 32 max per wiring

## Software option

	Line DMX	Art-Net	Options
Software Player	512/1024 DMX channels	1 universe (512) 2 universes (1024)	Live Board mode
Software Pro Software	512/1024 DMX channels	1 universe (512) 2 universes (1024)	Normal mode, 30 min audio and video timeline loop
Pixel mapping software	512/1024 DMX channels	4 universes (512) 8 Universe (1024)	Normal mode (512) 30 min (1024) audio and video timeline loop (1024)
Studio DMX 3D viewer	Full mode		
Wi-Light 2 App	Controls Player, Pro and Pixxem software over a local WiFi network		
Free software updates	Yes		

# Connectors and operation panel

## Rear panel & below panel

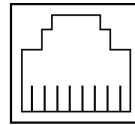
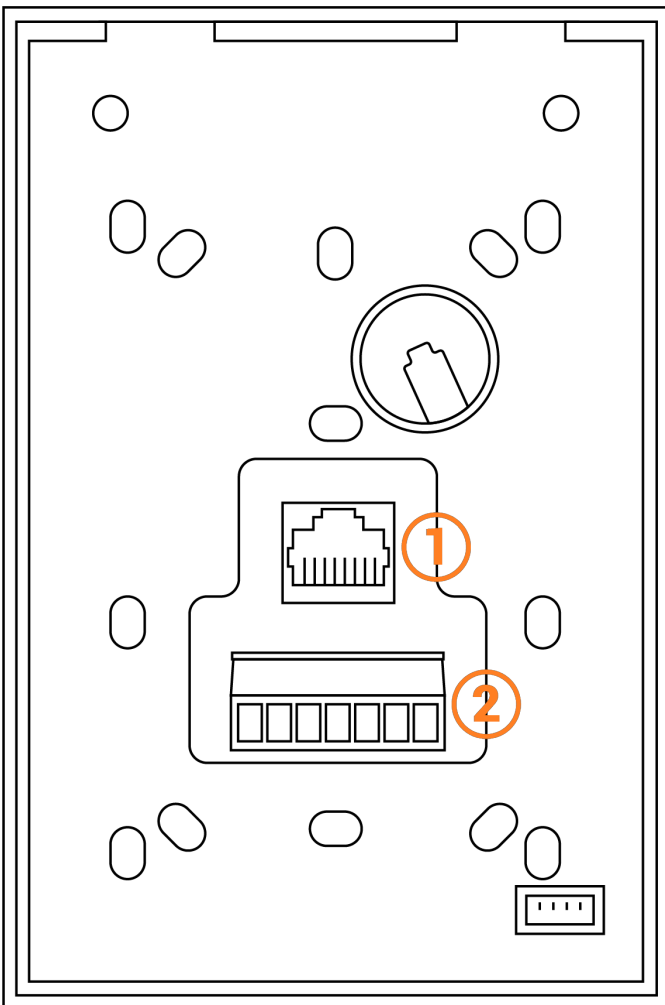

8 7 6 5 4 3 2 1

### 1- Rj45 Pinout :

1. GND
2. 5V DC Output - For triggers
- 3-6. TRIG A, B, C, D - Dry Contact pins
7. M/S DATA - Master/Slave Data
8. M/S CLK - Master/Slave Clock

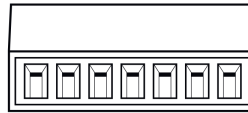

1 2 3 4 5 6 7

### 2 - 7 Pin Terminal block

1. DMX1-
2. DMX1+
3. GND (DMX 1+2)
4. DMX2-
5. DMX2+
6. GND (Power Input)
7. DC Power Input (VCC, 5-24V / (0.1A))

---

### 3 - USB-C Connector (5V DC input)

### 4 - Micro SD Port

### Caution

The RJ45 port functions are not available for serial numbers T00001 to T00199.

## Operation panel

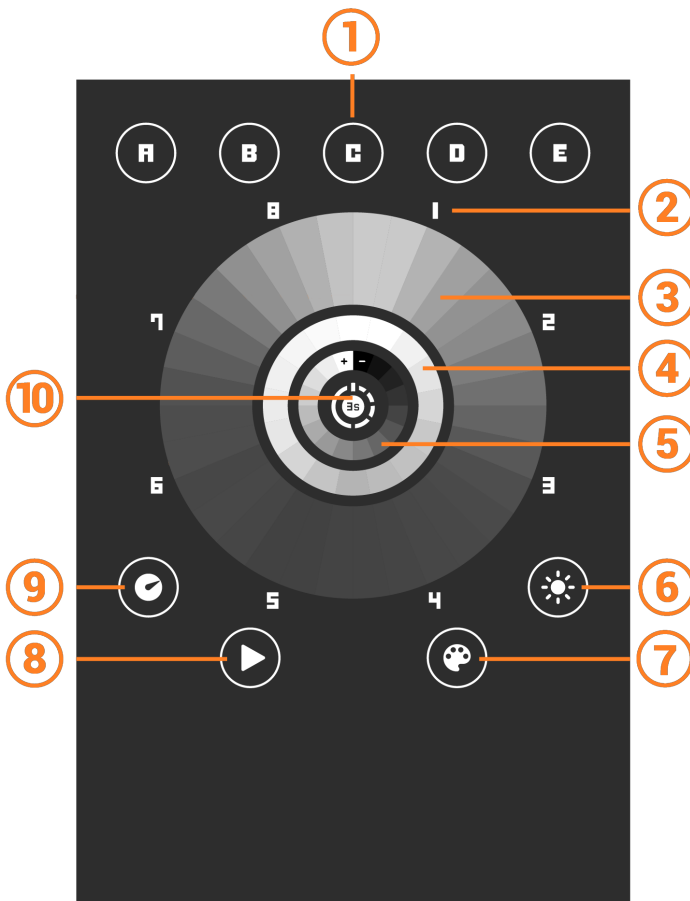

**1 - Zone selection (TOUCH 1024) | Page selection (TOUCH 512)** Tap to select zones/Pages individually. Hold 2s to combine Zones

**2 - Scenes #** Pick 1-8 (8 scenes per Zone or Page)

**3 - Tactile wheel picker and dial** Adjust colour temperature, intensity (+/-) or speed (+/-) and scenes. **Colour wheel** Pick RGB-AW colour for the selected zone (Colour mode selected)

**4 - Colour temperature** Cool to warm white representation for the selected zone (CCT mode selected)

**5 - Dimmer intensity** Light intensity (+/-) Representation (Dimmer mode selected)

**6 - Dimmer mode activation** Use the wheel to adjust brightness for selected zone (Active for 5s if no action)

**7 - Colour mode activation** Use the wheel to pick RGB-Amber-White colour. Hold 3s to enter cool/warm white mode

**8 - Scene mode activation** Use the wheel to start or stop the selected scene

**9 - Speed mode Activation** Use the wheel to change the current scene speed (Active for 5s if no second)

**10 - On / Off** Tap to cancel wheel settings (Hold 3s for black out)



# USB drivers installation

Install USB drivers to communicate with the device and change settings. Installation of USB drivers is required only for Windows at the end of installation. Drivers for Mac and Linux systems are installed automatically.

## USB drivers verification :

In the Windows Device Manager. Check that the device icon is visible in "USB Bus Controllers".

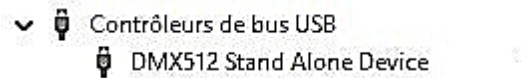

If drivers are not installed, the Windows Device Manager lists a device with a yellow warning.

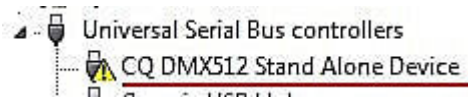

On Mac OS, simply check the USB device tree to view "DMX 512 Stand Alone Device". On Linux, use the "lsusb" command to view "DMX 512 Stand Alone Device" as a list.

## After control software installation and USB drivers

- Connect the device with the USB cable.
- Start the DEVICETOOL or the software and select "Open USB Device" or "USB" to check the success of drivers installation.

All connected and detected devices are listed.

# Multiple USB connections

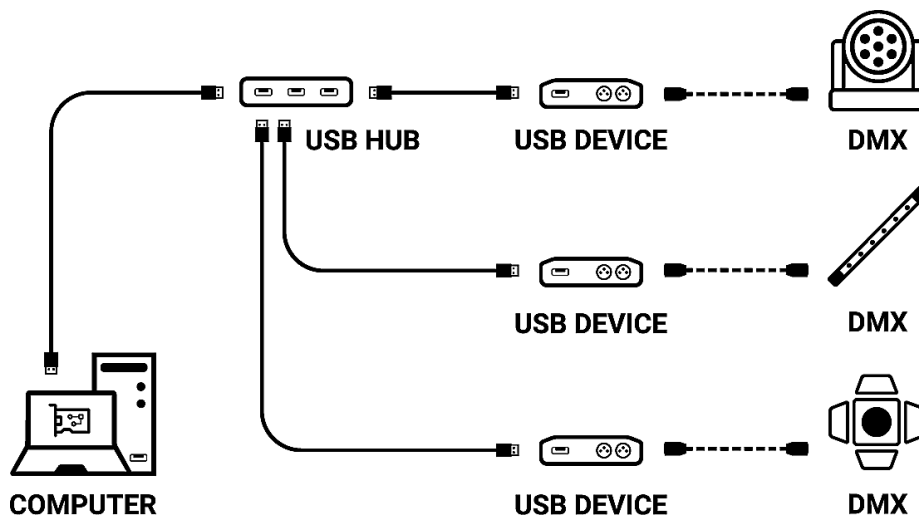

# Standalone mode settings



In standalone mode of the control software, configure the device according to the available options then select and configure the triggers of scenes to be written in memory.

## Device configuration

### IN/OUT tab

Select a DMX input/Output configuration of the device from the drop-down menu

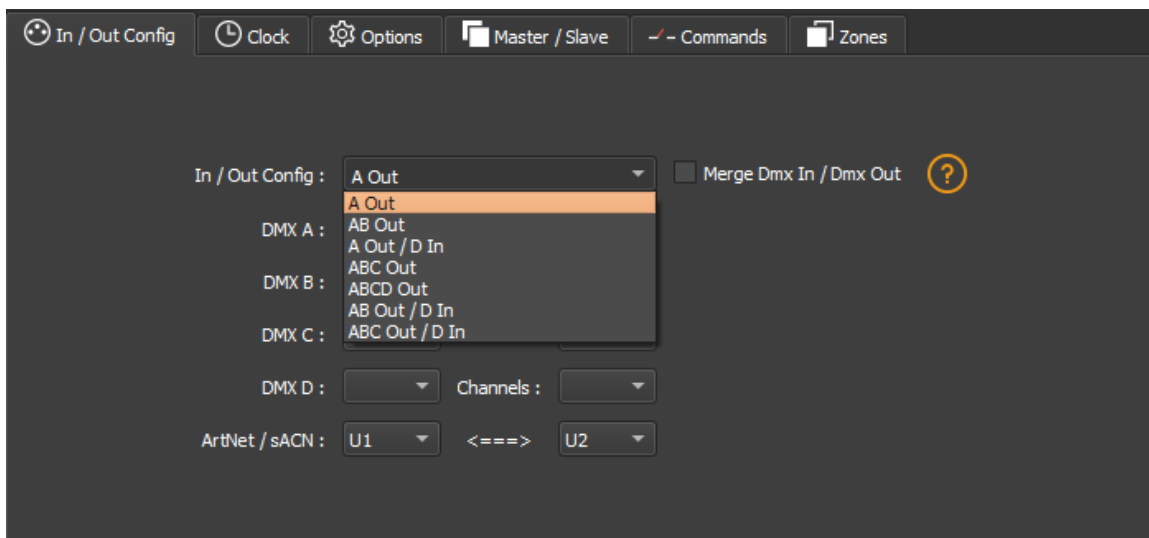

Available configurations will be displayed depending on the connected device depending on whether it has 1.2 or 4 DMX lines.

- **A OUT** - Assigns 1 output universe on the DMX line(s), for devices that have more than 1 DMX lines duplicate the universe on each.
- **AB OUT** - Assigns 1 different output universe on 2 DMX lines, for devices that have 4 DMX lines duplicates the first 2 lines on the next 2 lines.
- **A OUT/B or D IN** - Assigns 1 output universe on the first line(s) and uses the last DMX line as DMX input.
- **ABC OUT** - Assigns 1 different universe output on the first 3 DMX lines.
- **ABCD OUT** - Assigns 1 different universe output on 4 DMX lines.
- **AB OUT / D IN** - Assigns 1 different output universe on the first 2 lines and uses the last DMX line as DMX input.
- **ABC OUT / D IN** - Assigns 1 different output universe on the first 3 lines and uses the last DMX line as DMX input.

## "Merge DMX In / DMX Out" option

### **Available with devices with more than 2 or 4 DMX lines.**

Enable the option to re-inject line configured as an input (IN) to the line(s) configured in DMX outputs and thus merge them.

The merged DMX levels are compared and the highest is retained. We are talking about HTP (Highest Takes Priority).

Maintain manual control on some circuits with an external DMX console.

Create a multi-zone system by merging several cascading devices to obtain only one common DMX line.

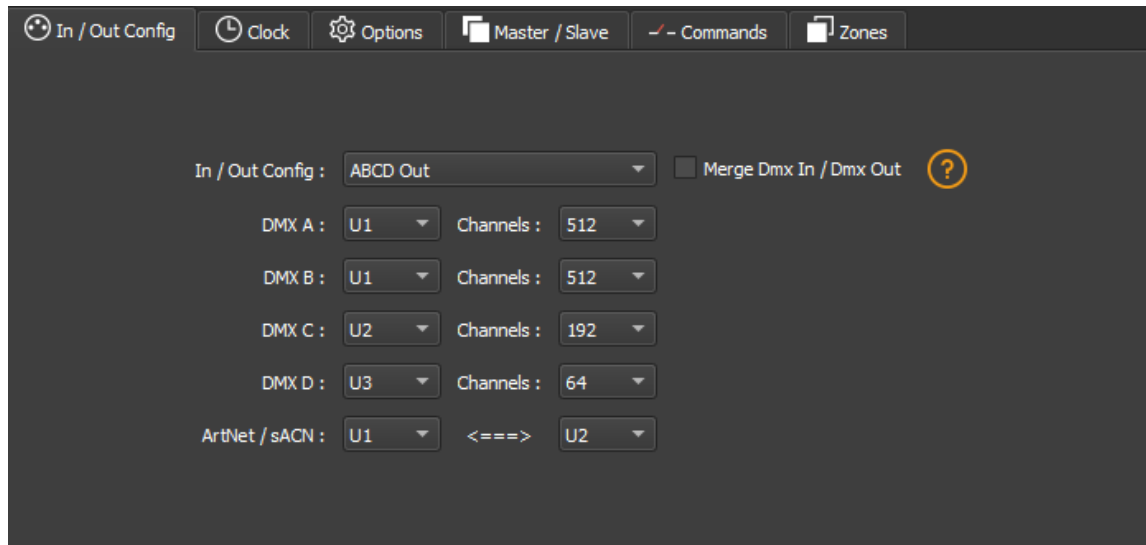

Assign any universe of the software to any DMX line assigned to output, choosing line by line (U1, U2...).

Optimize the size of shows saved in memory by reducing the number of circuits per universe depending on the channels used.

**Example:** If 150 channels are used in the show, select only the nearest higher value, here 192.

### Art-Net/sACN universe range:

Define the starting universe and the finish universe to write in memory on an external SD card for an Art-Net/sACN show.

Cf: *"Saving Art-Net or sACN to an external SD card"*

## Clock tab



Set up the selected device's internal clock.

- 1-Refreshes the device's current time display
- 2-Update the time after changing the hours/minutes/second fields.
- 3-Calibrate the compensation time according to the observed deviation.
- 4-Update the date.
- 5-Sync the date and time of the device with that of the computer.
- 6-Check to take into account the change of summer/winter time
- 7-Select the days of change of summer/winter time

## Options tab

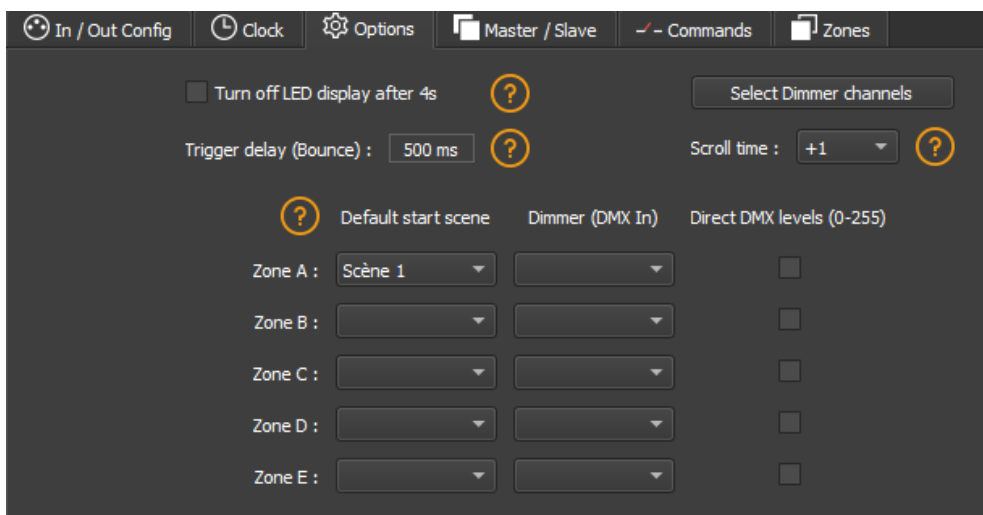

For devices with an LED display, turn it off after 4 seconds of inactivity by checking the option.

Select a default scene to play automatically after the device is turned on (with USB or external power supply). For multi-zones devices it is possible to set a default scene for each area.

**Note:** The selected default start scene loses its priority if another scene uses the "Restore if power off" option.

Cf: "Advanced trigger options"

Configure the "Select Dimmer channels" option to select separately the Dimmer or RGBW light intensity channels that will be controlled directly by Dimmer mode, dry contacts or via the infrared remote control.

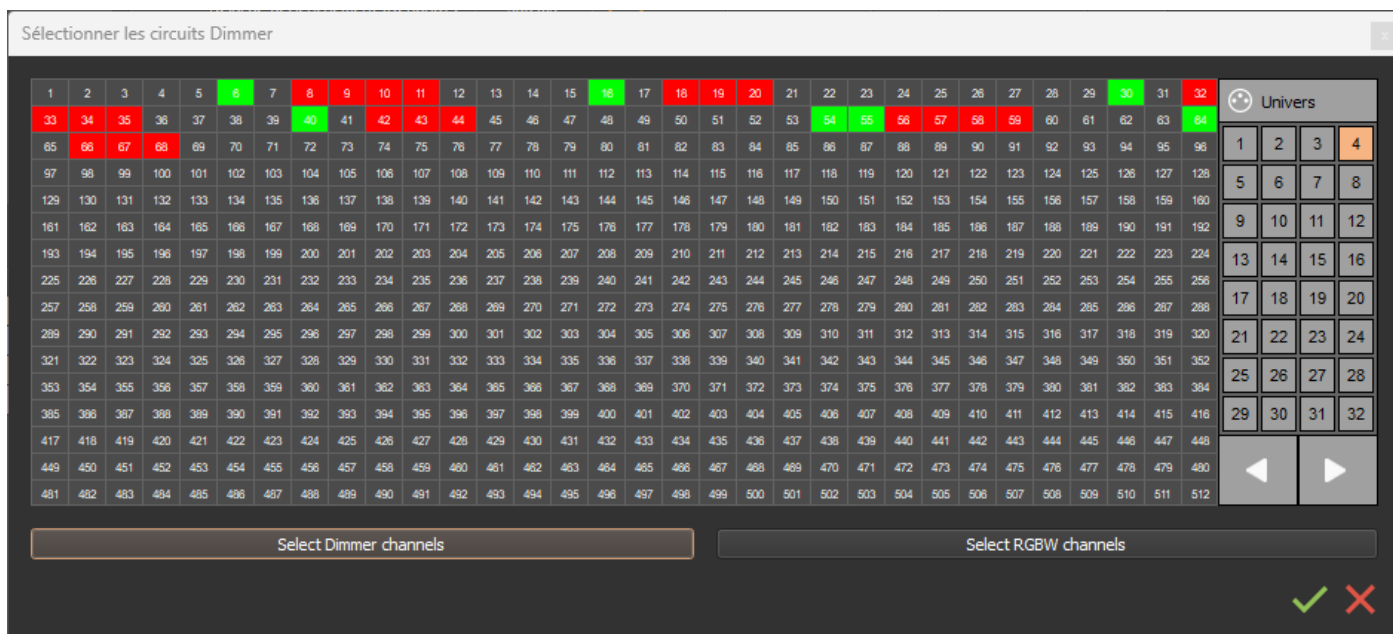

## Master/Slave tab

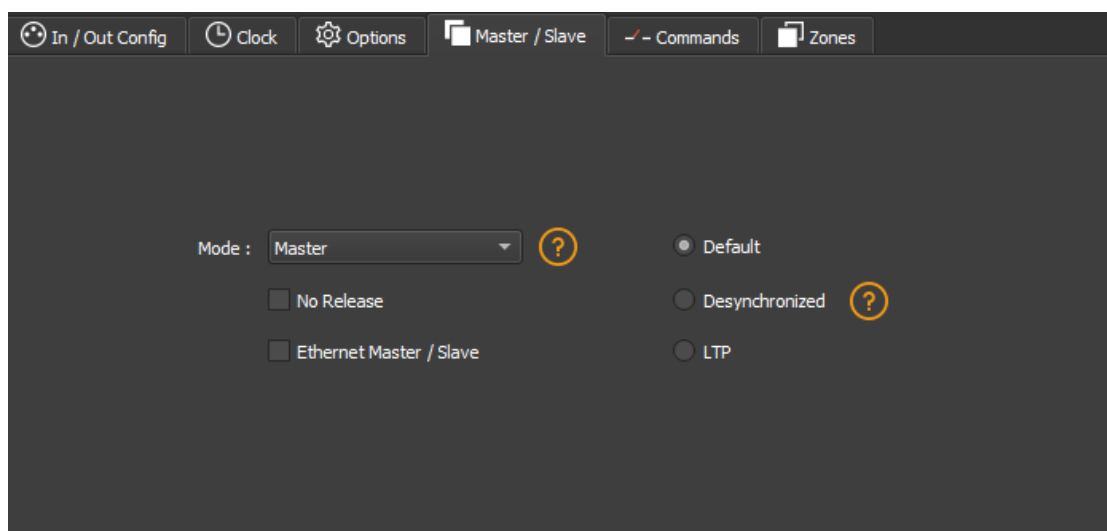

Connect multiple devices into USB so that they are detected by the software. Use the Master/Slave option to synchronise their standalone mode and DMX universe. When an device is set as a master in the software, the other devices are automatically put in slave mode. There are four different modes of master/slave interaction: By default, desynchronized, LTP, and no release.

### **Master/Slave mode "by default"**

A single device is defined as master (lower serial number by default), the others are automatically defined as slaves. The master device plays the current scene and synchronises the slave devices. The master forces slave devices to play the same scene and the same stage step simultaneously. Slave devices are forced to track the timings and triggers of the master and they cannot act otherwise, play or trigger a scene independently. The master can trigger and stop scenes from slave devices.

### **"Desynchronized" Master/Slave mode**

One device is defined as master, the others are automatically defined as slaves. All master device triggers are transmitted to slaves. However, slave devices are not synchronised with the master device synchronisation signal and retain individual control. Therefore, slaves can trigger and play different scenes at any time and not synchronised perfectly with those of the master. The master acts as a general remote control imposing the trigger on slaves with total priority. The master can trigger ON and OFF scenes from the slave device.

### **Master/Slave mode "LTP"**

LTP means "Latest Takes Priority / The latter has Priority". All devices are defined as slaves. The devices are not synchronised with timing and can trigger and play different scenes by themselves. However, device triggers are automatically transmitted to other connected devices and slave devices are forced to trigger the same scene. In this mode, each device acts as a general remote control imposing triggering on other slaves without synchronisation.

### **Master/Slave mode "No release"**

This option is only available with LTP or DESYNCHRONIZED modes. Only ON triggers of the master device are executed and functional. All OFF triggers are ignored and slave devices continue to play their current scene. Each slave device can choose whether or not to release its scene depending on whether the option is enabled or not.

Cf: "*Wiring diagram for Master/Slave installation*"

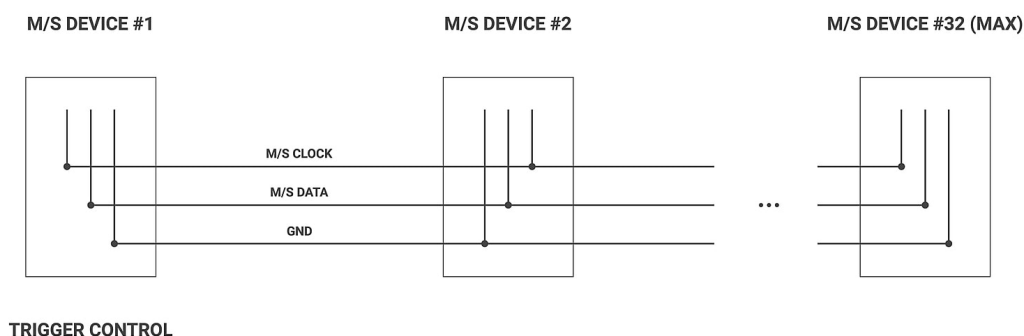

## Commands tab

Assign external contacts, among those available for your device, to trigger some standalone mode commands: Dimmer +, Dimmer -, Blackout, Speed +, Speed -, Pause, Scene +, Scene - and Zone.

**Note:** Be careful not to use the same command trigger as the one used for a scene and vice versa. Cf: *"Choice of triggers by external contacts"*

The last assigned contact will take priority over the other.

Use 2 types of Short/Hold contact and thus assign an identical contact to 2 different commands. (here as an example with the Dimmer +; Dimmer -)

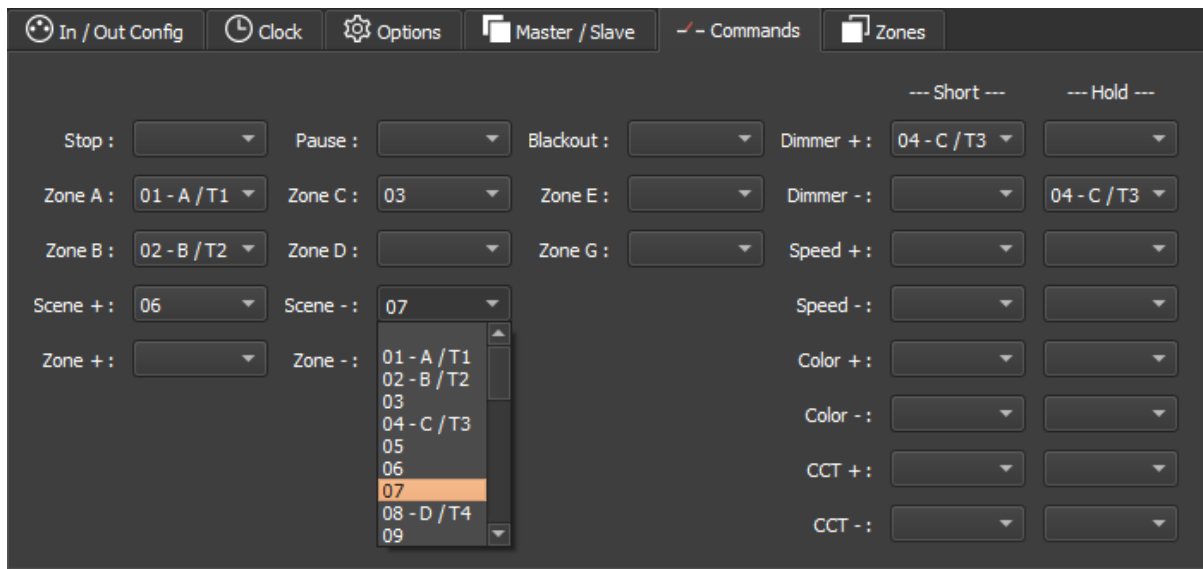

## Zones tab

The multi-zone option allows you to play multiple scenes simultaneously in defined areas.

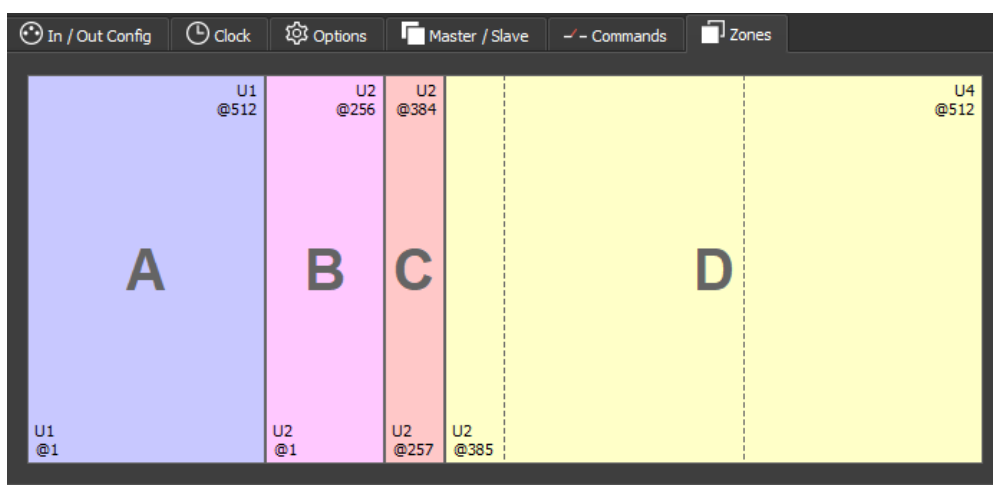

The tab displays the DMX configuration summary of the associated DMX zones and addresses.

Double-click to switch to **edit mode**.

Set the area settings manually, moving the center bar or digitally choosing the range of the area in the fields.

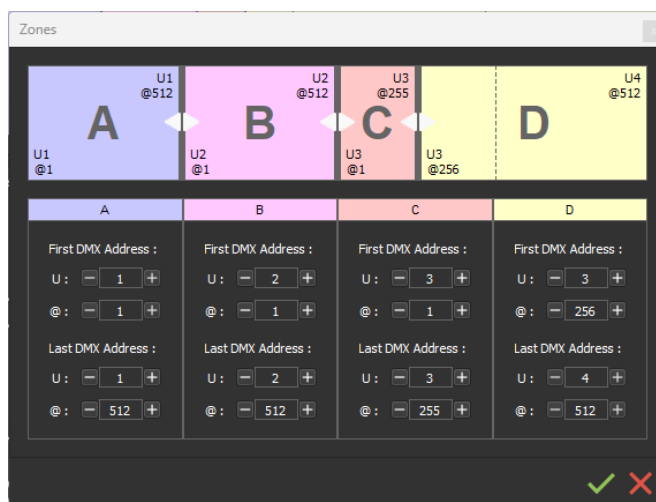

**Note:** Verify that the addresses of DMX patches and devices match the defined areas.

## Configuring the standalone modes of the device

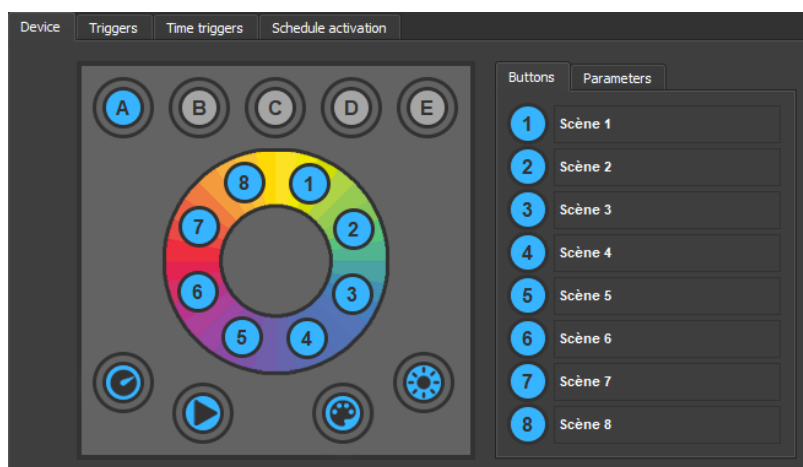

In the "Device" tab enable or disable the standalone modes of the device by clicking on the icons of its schematic representation.



The icon is selected when it appears in blue.

### Calibration of Cold White, Warm White and UV components.

Select or deselect the cold white, warm white and UV modes to apply these components to the active RGB components according to the selected fusion mode.

Select or deselect warm white and UV modes.

Click on the icon  to select their merge mode.

Select the light animations of the device, in the setting tab of the right section.













Buttons Parameters

Cold White 

Warm White 

UV 

Delay :   

	Anim	Play	
<input checked="" type="checkbox"/>	#1		
<input type="checkbox"/>	#2		
<input type="checkbox"/>	#3		
<input type="checkbox"/>	#4		
<input type="checkbox"/>	#5		
<input type="checkbox"/>	#6		

## Scenes selection and configuration

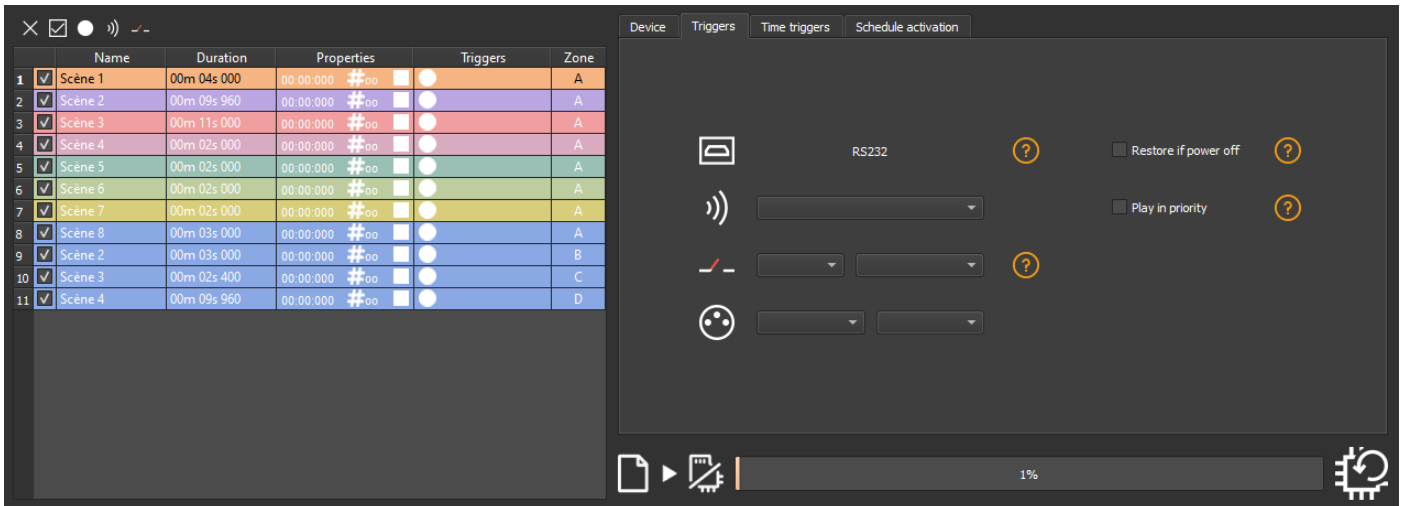

Check to select the scenes to write in memory and assign triggers from those available by your device.

## Choice of triggers

In the "Triggers" tab, select and assign different types of triggers.

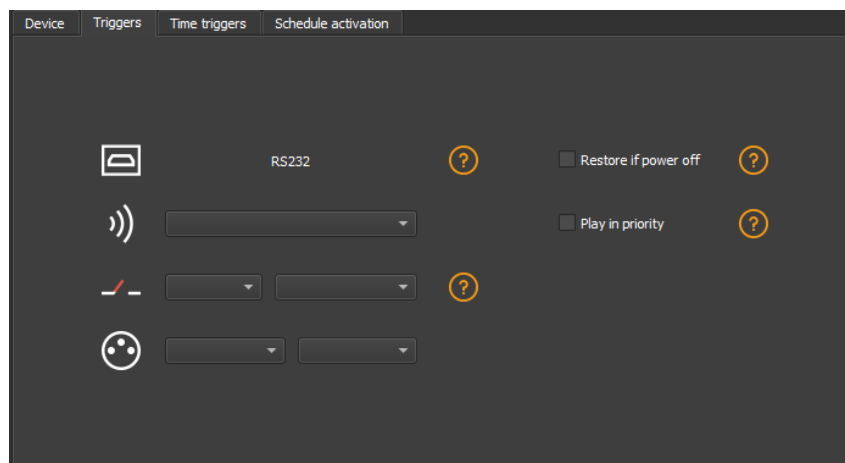

## Triggers by buttons in the "Device" tab

Assign physical buttons to scenes using the schematic representation of the device in the "Device" tab.

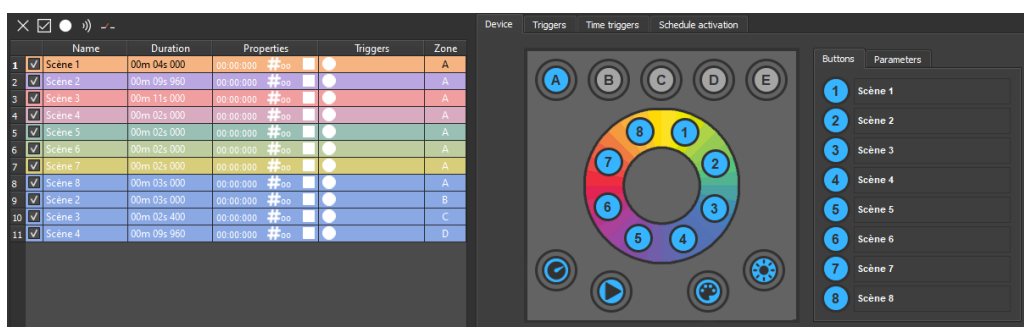

After checking the scenes to write in memory, drag and drop the scenes from the list on the right to the list on the left based on their respective area or page.

Automatically assign buttons to all scenes in the list according to their area, by clicking on the "button" icon on the toolbar of the scenes list.

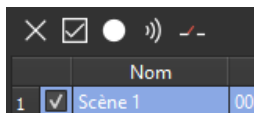

### External contacts Trigger:

Depending on the device, several external contacts are available: Trig A, Trig B, Trig C ..., and the Use a multiplexing device to extend the number of contacts when possible.(from 3 to 7; from 4 to 15; from 5 to 31 ...) Contact reaction time, 5ms (0.005s)

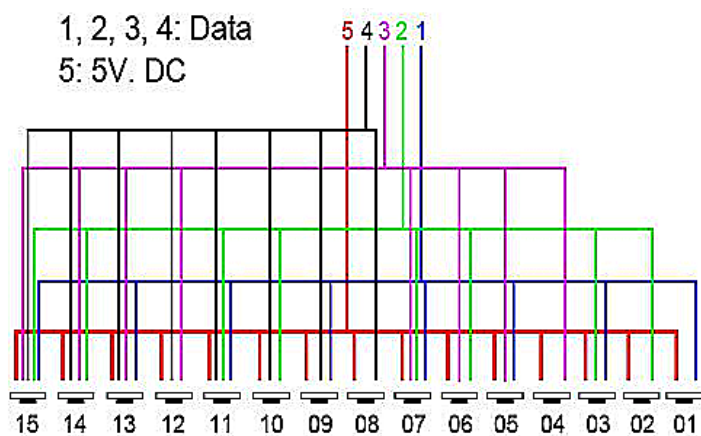

Example of multiplexing system with 4 external contacts extended to 15.

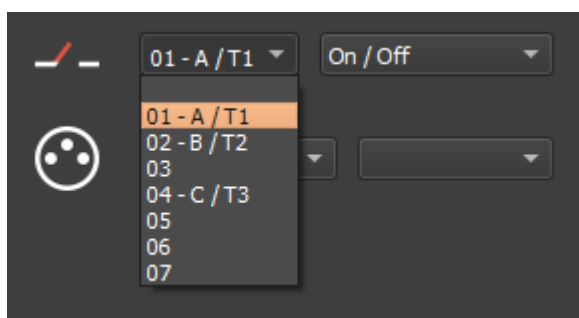

Select a scene from the list and assign it a contact from those available through the device.

### Option of triggers

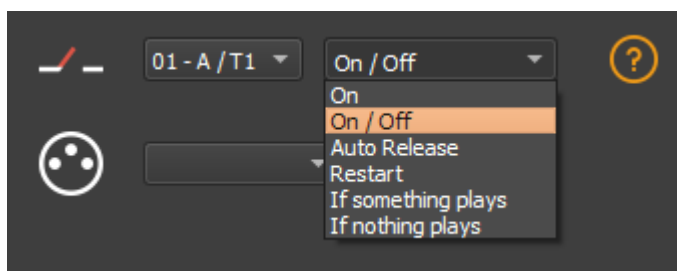

Select a trigger option from the drop-down menu next to it.

**On:** Activating the contact makes the scene play (the only trigger action is to start the scene).

**On/Off:** Activating the contact starts the scene, subsequent activation stops the scene. Each trigger action will reverse the stage state (start/stop).

**Auto Release:** The scene is played only while the contact is enabled. When the contact is released, the scene stops.

**Restart:** If the scene is playing, enabling the contact restarts the scene from its beginning. If the scene is not being played, it will start. External contact reaction time: 8 ms (0.008 s) / time between 2 contacts: 500 ms (0.5 s)

**If something plays:** Play the selected scene if a scene is already played.

**If nothing plays:** Play the selected scene if nothing plays.

These two interdependent options allow the same contact to be assigned to two different scenes.

**Note:** Be careful not to use the same scene trigger as the one used for a command and vice versa. Cf: "Order tab"

The last assigned contact will take precedence over the other.

Automatically assign external contacts to all scenes in the list by clicking the external contact icon on the scene list toolbar.

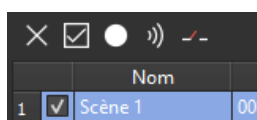

## Triggers by DMX-IN

255 trigger channels and up to 255 levels per channel are available.

Select a scene from the list and assign it a channel number associated with a trigger level. A trigger level corresponds to the threshold above which the scene is triggered.

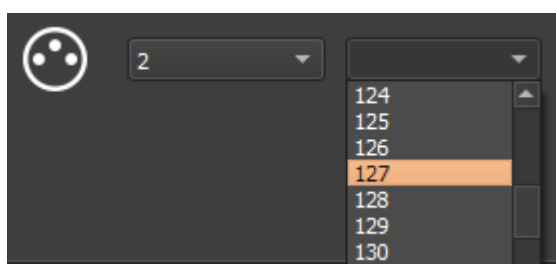
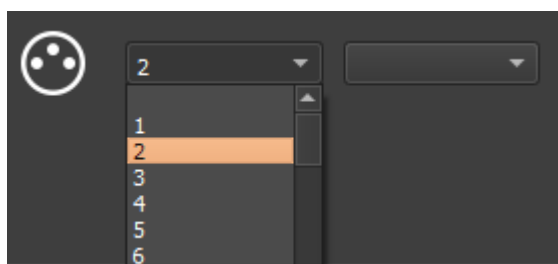

**Note:** To configure triggers in DMX-IN, one of the DMX lines must be Select as input in the "IN/OUT Config tab."

## Time triggers

Select a scene from the list and assign it a trigger period. Organize and repeat triggers over the year in specific ways.

### Single trigger

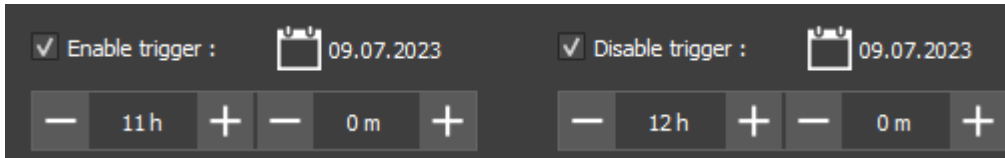

Check "Enable trigger" and "disable trigger" to determine a period. Select a date (timetable icon) and time (hour/minutes fields) of trigger activation and then disable trigger.

Without shutdown, the scene will play indefinitely until another event replaces it with another scene triggering or manual shutdown.

### Permanent trigger

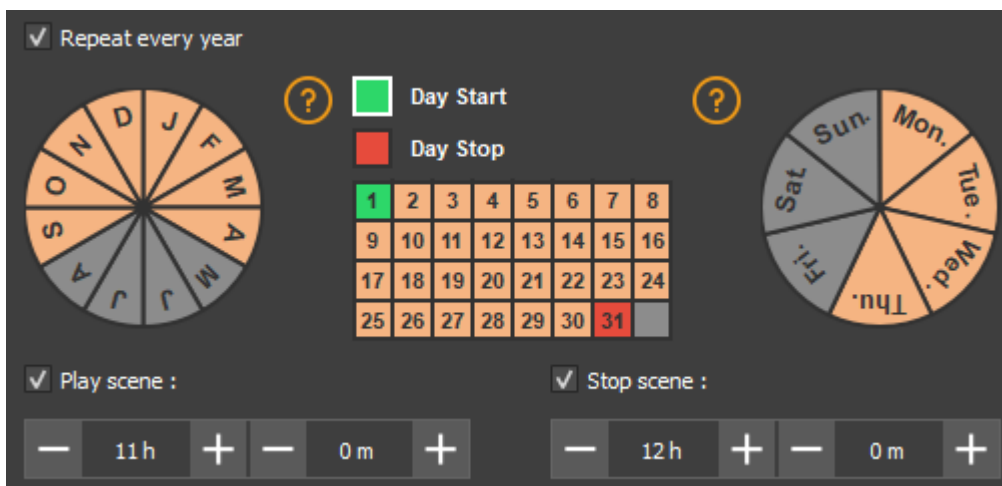

For example above: the scene plays from Monday to Thursday from 11am to noon from 1st to 20 of each month, from September to April.

Check "Repeat every year" to set the monthly and then daily triggers.

Select or deselect the months of active triggers in the left wheel. (selection in orange)

After selecting the green square for the start day or the red square for the end day, determine the period of the month during which the trigger will be active.

Select or deselect the days of the week or the trigger will be active in the right wheel. (selection in orange)

Select a start time and an end time of trigger.

**Note:** For a daily repetition, if the start time is after the end time, the trigger will stop the next day, even if the next day has not been selected.

### Light intensity trigger

This option is available for devices with an Infrared kit.

Cf. "Use the remote control"

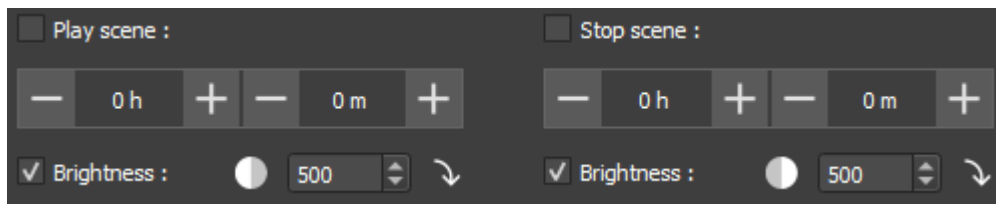

Check "brightness" to activate or disable the trigger according to the ambient light.

Once checked this option cancels and replaces the time trigger.

 Click on the icon to determine if the trigger activates or disables during the upward phase (day to night) or downward phase (night to day).

 Click the arrow to set a value that corresponds to the light sensitivity and at which the trigger activates or disables.

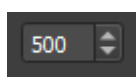
 Using the arrows, adjust the value that fits into the dedicated field.

### Priority of hourly trigger

When multiple scenes have the same time trigger (date + hour + minute), only the last scene in the list will be triggered. The others will be ignored when triggering.

## Advanced trigger options.

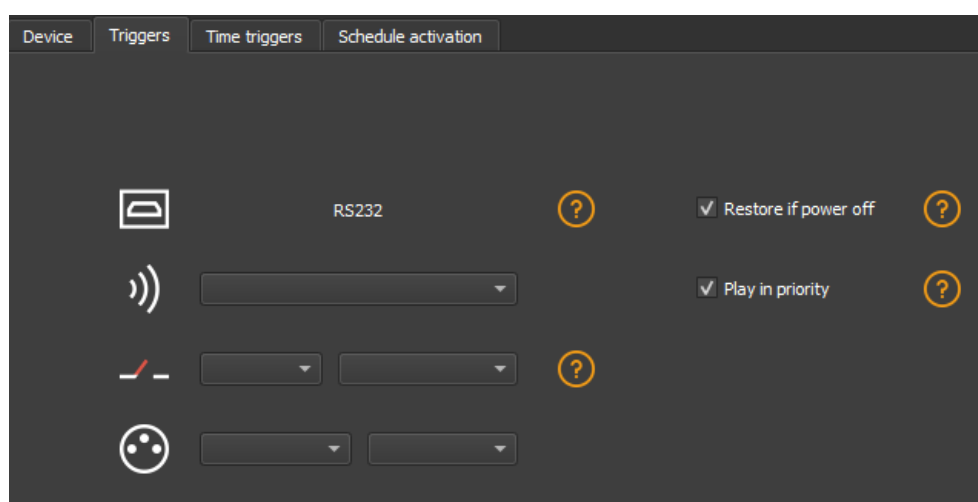

## Restore after power off

By checking this option in the "Triggers" tab, the selected scene takes priority on the boot scene (see "Options tab") when the power supply is restored.

If all scenes have the option checked, the last active scene is replayed.

## Play in priority

By checking this option in the "Triggers" tab, the selected scene plays continuously until its end, without taking into account other triggers, except for time triggers and physical buttons on the device.

# Save in memory option

Check scenes that need to be saved in memory.

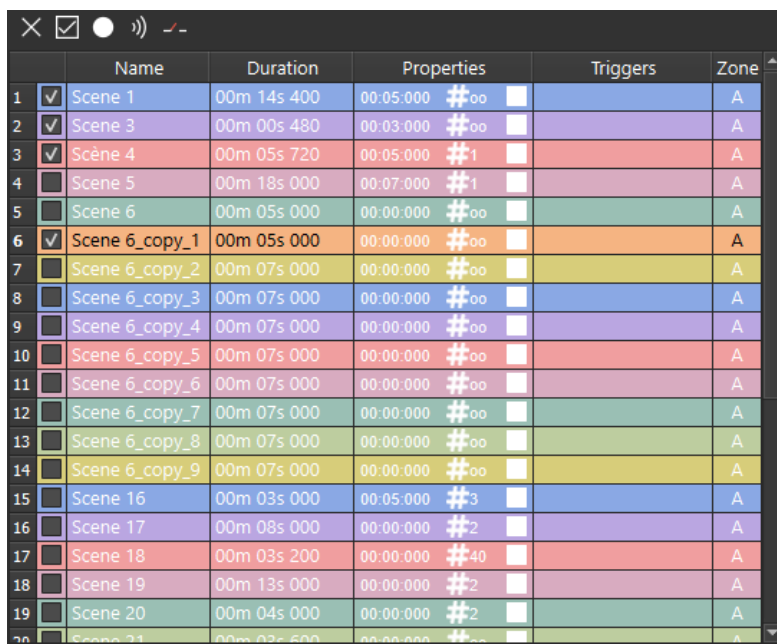

	Name	Duration	Properties	Triggers	Zone
1	<input checked="" type="checkbox"/> Scene 1	00m 14s 400	00:05:000 #00	<input type="checkbox"/>	A
2	<input checked="" type="checkbox"/> Scene 3	00m 00s 480	00:03:000 #00	<input type="checkbox"/>	A
3	<input checked="" type="checkbox"/> Scene 4	00m 05s 720	00:05:000 #1	<input type="checkbox"/>	A
4	<input type="checkbox"/> Scene 5	00m 18s 000	00:07:000 #1	<input type="checkbox"/>	A
5	<input type="checkbox"/> Scene 6	00m 05s 000	00:00:000 #00	<input type="checkbox"/>	A
6	<input checked="" type="checkbox"/> Scene 6_copy_1	00m 05s 000	00:00:000 #00	<input type="checkbox"/>	A
7	<input type="checkbox"/> Scene 6_copy_2	00m 07s 000	00:00:000 #00	<input type="checkbox"/>	A
8	<input type="checkbox"/> Scene 6_copy_3	00m 07s 000	00:00:000 #00	<input type="checkbox"/>	A
9	<input type="checkbox"/> Scene 6_copy_4	00m 07s 000	00:00:000 #00	<input type="checkbox"/>	A
10	<input type="checkbox"/> Scene 6_copy_5	00m 07s 000	00:00:000 #00	<input type="checkbox"/>	A
11	<input type="checkbox"/> Scene 6_copy_6	00m 07s 000	00:00:000 #00	<input type="checkbox"/>	A
12	<input type="checkbox"/> Scene 6_copy_7	00m 07s 000	00:00:000 #00	<input type="checkbox"/>	A
13	<input type="checkbox"/> Scene 6_copy_8	00m 07s 000	00:00:000 #00	<input type="checkbox"/>	A
14	<input type="checkbox"/> Scene 6_copy_9	00m 07s 000	00:00:000 #00	<input type="checkbox"/>	A
15	<input type="checkbox"/> Scene 16	00m 03s 000	00:05:000 #3	<input type="checkbox"/>	A
16	<input type="checkbox"/> Scene 17	00m 08s 000	00:00:000 #2	<input type="checkbox"/>	A
17	<input type="checkbox"/> Scene 18	00m 03s 200	00:00:000 #40	<input type="checkbox"/>	A
18	<input type="checkbox"/> Scene 19	00m 13s 000	00:00:000 #2	<input type="checkbox"/>	A
19	<input type="checkbox"/> Scene 20	00m 04s 000	00:00:000 #2	<input type="checkbox"/>	A
20	<input type="checkbox"/> Scene 21	00m 03s 500	00:00:000 #2	<input type="checkbox"/>	A

Click on the "Write in Memory" button



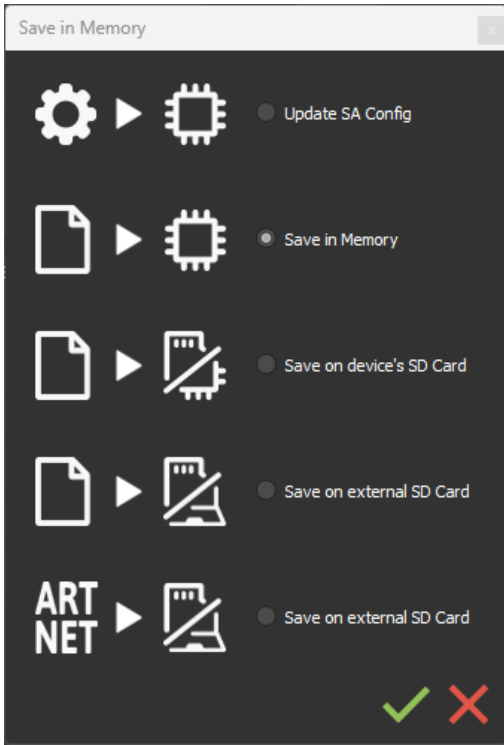

Select the desired option in the Scenes Write window.

## Basic backup

**Write standalone configuration:** Change only certain settings in the configuration of a show already written in memory. Reduces backup time.

**Write to Memory:** Default backup in the internal memory of the device.

## Save to an internal and external micro SD card

For devices with a micro SD port.

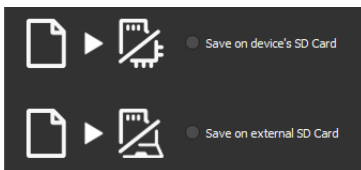

Save scenes to a micro SD card (Class 10) installed in the device's SD card reader or in the computer drive. The card must be CLASS 10, formatted in FAT or FAT 32 with a maximum capacity of 256 GB. It is recommended to use the largest allocation unit size available when formatting.

**Write to the SD card of the device:** SD card installed in the device drive

**Write to an external SD card:** SD card connected to the computer

Note: Save to the root directory of the SD card.

## Backing up Art-Net or sACN to an external SD card

For devices with a micro SD port and an Ethernet port.



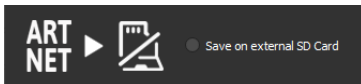

**Art-Net** - Write to an external SD card: Save up to 8 universes only on micro SD to render an Art-Net or sACN show independently.

Set the universe range in the IN/OUT config tab.Cf:

Pre-commissioning verification:

Connecting the RJ45 cable before power on.

Connection to the local network.Cf: "Ether Ethernet connection and configuration"

Configuring the device in Art-net or sACN mode via the software or DeviceTool.

**Note:** Once in Art-Net (Ar) or sACN (AC) mode, the device is no longer visible on the local network.

In Art-Net the device will use Broadcast to play the show on the network.

In sACN the device will use the Multicast to play the show on the network.

## Standalone use

### Switch to standalone mode

The device switches to standalone mode automatically after 5 seconds after power on and if no software connection is made.

### External and USB power supply

The external power supply is only used for "Autonomous" mode.But it is possible to connect a USB cable and power supply at the same time, even if this configuration is not recommended.If a USB cable is connected to the device when running in standalone mode, the device will detect a possible connection to a computer but this will not affect the scenes that play.

### Charging the clock battery

Before installing the device in standalone mode, connect the device for 1 hour to charge the clock battery and avoid losing the saved time configurations.

### Play a show via a Micro SD Card

To play the SD show standalone, insert the card into the micro SD drive of the device. When

powered, the screen displays "Sd" to indicate that the SD file of the project is being played.

**Note:** The show file must be saved to the root directory of the micro SD. It will not be read if the file is renamed or saved in a folder or subdirectory.

**Notes on Recommended Specifications for SD cards:**

The class of the SD card indicates its read/write speed. Higher class numbers (for example, Class 10) offer faster speed and better compatibility.

Class 6 or higher micro SD cards are preferable for optimal system performance. Older Class 2 and 4 SD cards may not work.

Prefer Class 10 micro SD cards for mobile phones.

# Dimensions and mounting

Dimensions in mm.

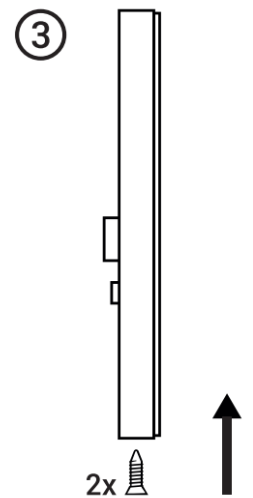
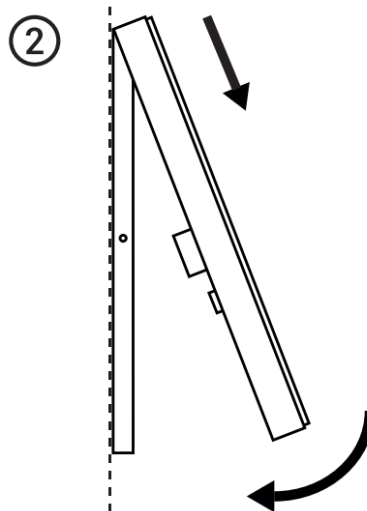
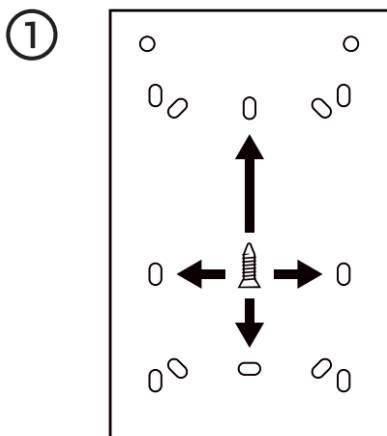
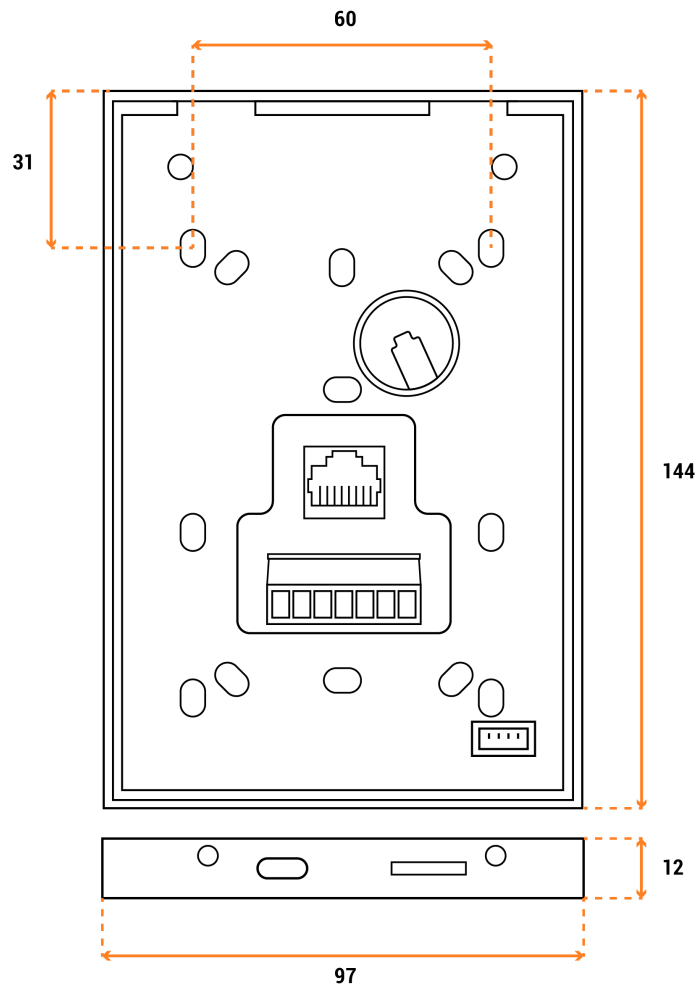

# Troubleshooting

The device is not detected by the DeviceTool or USB software.	<p>Unplug to restart the device.</p> <p>Change the USB cable</p>
The device is not detected by the DeviceTool or Ethernet software.	<p>Unplug to restart the device.</p> <p>Change the Ethernet cable</p> <p>Check the selection of the Ethernet network before opening.</p>
The device is not detected on the network.	<p>Check the mode of communication with LED signals and reconfigure the device via USB if necessary</p> <p>Verify that the IP addresses and subnet mask are configured correctly.</p> <p>Update the firmware of the device via the software or DeviceTool</p> <p>Update the software with the latest version and try again</p> <p>Open and allow communication ports used by the device. Some local networks may require manual opening of the following UDP Ports: 8011 + 8012 for communication between the device and software.</p>
The device is blocked in standalone mode and it cannot establish communication with the software.	<p>Check the firmware and software version.</p> <p><b>Device with display</b> When working properly: The screen indicates "ON" when connected to the computer, then it displays "SA" and "00" (or a scene number). When you start the software and the device is properly detected, you should see "PC".</p> <p><b>Device without display</b> Check the mode of communication with LED signals.</p> <p>During the 5 seconds before the device switches to standalone mode:</p> <ol style="list-style-type: none"> <li>1) Create a small show with a scene (in demo mode) and close the software after saving the show.(optional)</li> <li>2) Unplug the device.</li> <li>3) Start the software and wait for the software to be on the 1st page of the wizard with the selected USB device.</li> </ol>

	<p>4) Plug in the device and start the software IMMEDIATELY .Simply confirm all the steps of the wizard.You should see the device well detected and listed in the wizard.</p> <p>5) Open the software and quickly write the small show in memory.</p> <p>Writing a new scene cleanses memory and does not allow the infinite loop to reproduce.</p>
<p>The device does not restore the Art-Net or sACN show.</p>	<p>Before commissioning, plug the RJ45 cable before powering.</p>
	<p>Replugging the power supply</p>
	<p>Insert the SD card again (Reset)</p>
	<p><b>Device with display</b>  Select ArtNet (Ar) mode again, sACN (AC) in the advanced F3 menus of the device (mode button).</p> <p><b>Device without display</b>  Select ArtNet, sACN mode again via the software or DeviceTool.</p>

If you experience unlisted issues, contact your seller or manufacturer directly to indicate your problem and receive a solution.

Product design and specifications are subject to change without prior notice.

Older devices (sold before 2020) are not compatible with PRO DMX version 2



191 Allée de Lauzard  
34980 St Gély du Fesc, FRANCE  
Web: [www.chromateq.com](http://www.chromateq.com)  
Email: [info@chromateq.com](mailto:info@chromateq.com)  
Phone: +33 952210755

Wechat: Chromateq  
WhatsApp: +8613422062209  
QQ: 2908265661



Guaranteed products: 1-3-5 years  
Software pack: <https://chromateq.com/dmx-software-downloads/>

Copyright © 2021 - CHROMATEQ.All rights reserved.