

MIPRO[®]

MA-808

Portability

Simplicity

Flexibility

Portable Wireless PA System

User Guide



IMPORTANT SAFETY INSTRUCTIONS

1. Read these instructions.
2. Keep these instructions.
3. Heed all warnings.
4. Follow all instructions.
5. Do not use this apparatus near water.
6. Clean only with a dry cloth.
7. Do not block any ventilation openings. Install in accordance with the manufacturer's instructions.
8. Do not install near any heat sources such as radiators, heat registers, stoves, or other apparatus (including amplifiers) that produce heat.
9. Do not defeat the safety purpose of the polarised or ground plug: A polarised plug has two blades with one wider than the other. The wide blade is provided for your safety. When the provided plug does not fit into your outlet, consult an electrician for replacement of the obsolete outlet.
10. Protect the power cord from being walked on or pinched particularly at plug, convenience receptacles, and the point where they exit from the apparatus.
11. Only use attachments/accessories specified by the manufacturer.
12. Use only with a cart, stand, tripod, bracket, or table specified by the manufacturer, or sold with the apparatus. When a cart is used, use caution when moving the cart/apparatus combination to avoid injury from tip-over.
13. Unplug this apparatus during lightning storms or when unused for long periods of time.
14. Refer all servicing to qualified service personnel. Servicing is required when the apparatus has been damaged in any way, such as power-supply cord or plug is damaged, liquid has been spilled or objects have fallen into the apparatus, the apparatus has been exposed to rain or moisture, does not operate normally, or has been dropped.
15. To reduce the risk of fire or electric shock, do not expose this apparatus to rain or moisture.
16. Apparatus should not be exposed to dripping or splashing and no objects filled with liquids, should be placed on the apparatus.
17. Use only with the battery which specified by manufacturer.
18. The power supply cord set is to be the mains disconnected device.
19. Where the MAINS plug or an appliance coupler is used as the disconnect device, the disconnect device shall remain readily operable.
20. Maximum operating temperature range is 50°C (122°F).
Note: Battery characteristics may limit this range.



® 201-180636

WARNING

1. FOR OUTDOOR USE:

To reduce the risk of fire or electric shock, do not expose this apparatus to rain or moisture.



2. UNDER WET LOCATION:

Apparatus should not be exposed to dripping or splashing and no objects filled with liquids, such as vases should be placed on the apparatus.

3. SERVICE INSTRUCTIONS:

CAUTION - These servicing instructions are for use by qualified service personnel only.

To reduce the risk of electric shock, do not perform any servicing other than that contained in the operating instructions unless you are qualified to do so.

**CAUTION**
RISK OF ELECTRIC SHOCK
DO NOT OPEN

 This symbol indicates that dangerous voltage constituting a risk of electric shock is present within this unit.

 This symbol indicates that there are important operating and maintenance instructions in the literature accompanying this unit.

FC & IC - ID

THIS DEVICE COMPLIES WITH PART15 OF THE FCC RULES AND RSS-123 ISSUE2 OF CANADA. OPERATION IS SUBJECT TO THE FOLLOWING TWO CONDITIONS:

(1) This device may not cause interference.

(2) This device must accept any interference, including interference that may cause undesired operation of the device. This equipment complies with FCC RF radiation exposure limits set forth for an uncontrolled environment.



“This product can only be used at the area that the altitude is lower than 2000m for safety purpose.”



“This product can be used in non-tropical locations only for safety purpose.”

Disposal

Dispose of any unusable devices or batteries responsibly and in accordance with any applicable regulations.

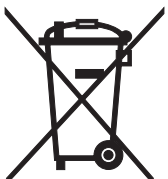

Disposing of used batteries with domestic waste is to be avoided!

Batteries/NiCad cells often contain heavy metals such as cadmium(Cd), mercury(Hg) and lead(Pb) that makes them unsuitable for disposal with domestic waste. You may return spent batteries/accumulators free of charge to recycling centres or anywhere else batteries/accumulators are sold.

2005-08-13

By doing so, you contribute to the conservation of our environment!

Portable Wireless PA System

I. Part Names

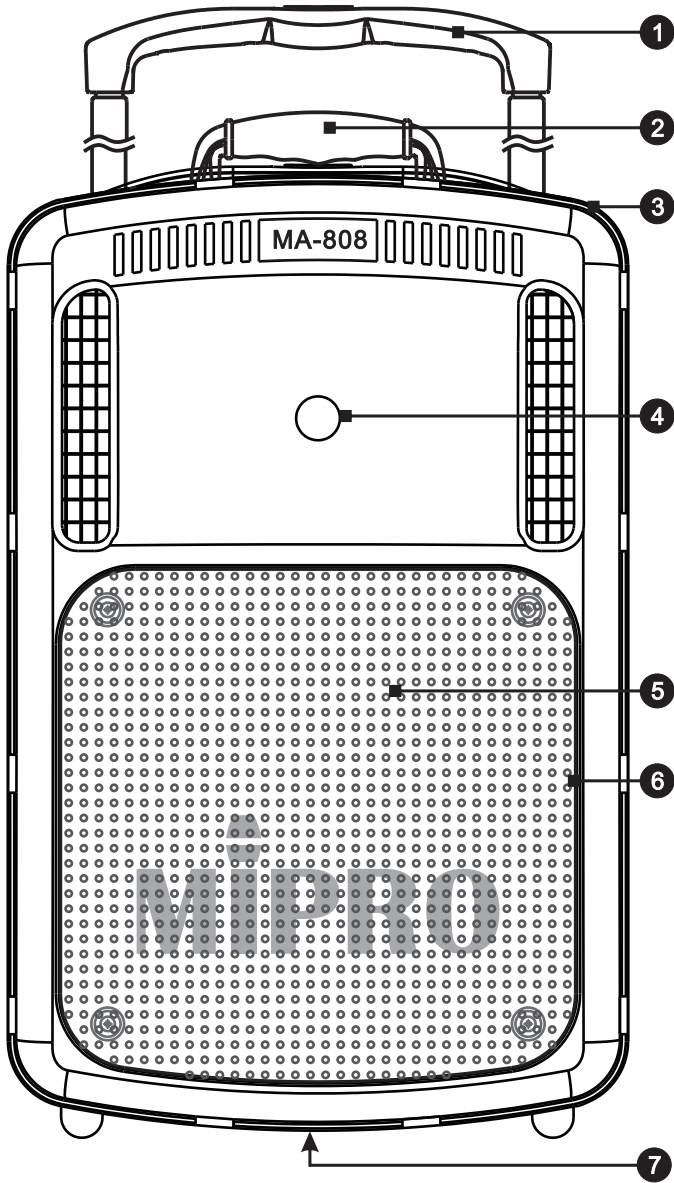

Fig. 1: Front Panel

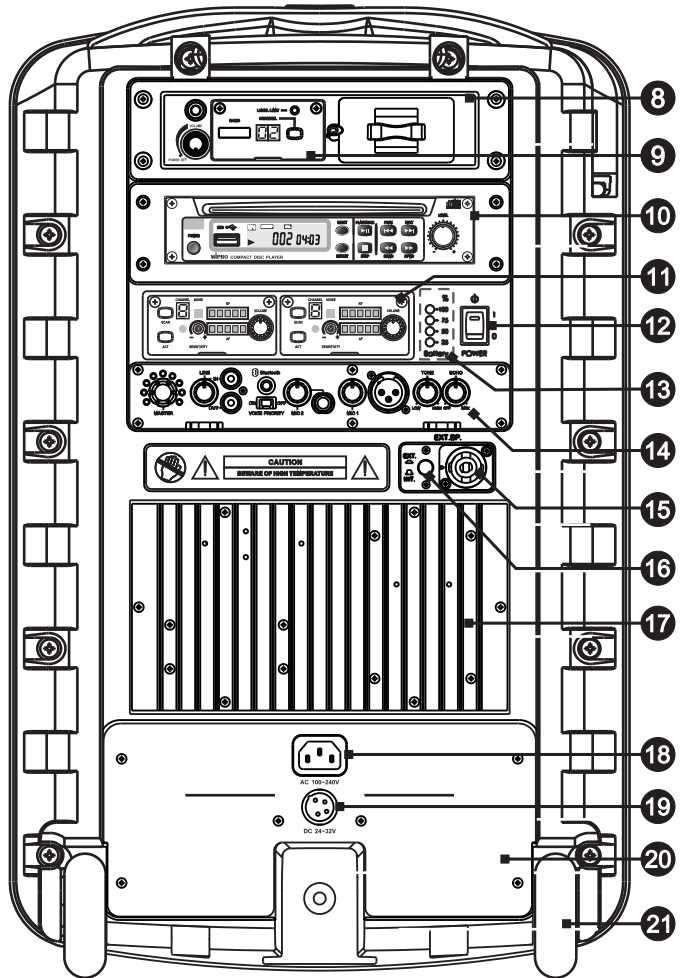

Fig. 2: Rear Panel

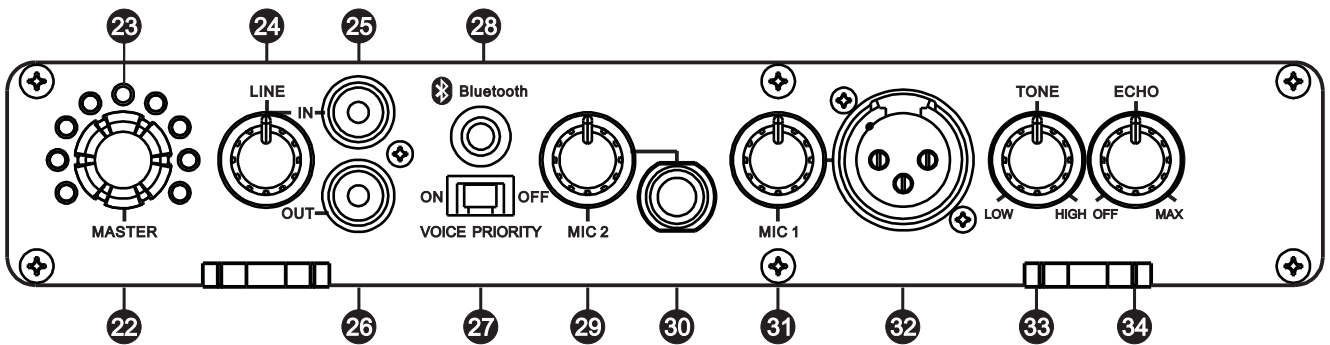

Fig. 3: Control Panel

Portable Wireless PA System

Front Panel: Fig. 1

- ① Retractable Carry Handle
- ② Fixed Handle
- ③ Microphone Storage Compartment
- ④ Treble Speaker
- ⑤ Bass Speaker
- ⑥ Speaker Grille
- ⑦ Tripod Stand Mount

Rear Panel: Fig. 2

- ⑧ Optional Receiver or Interlinking Transmitter Module Frame
- ⑨ Optional Receiver or Interlinking Transmitter Module
- ⑩ Optional CD/MP3 Media Player
- ⑪ Optional Wireless Receiver Module(s)
- ⑫ Master Power Switch
- ⑬ Battery Status Indicators
- ⑭ Control Panel
- ⑮ Speakon Connector
- ⑯ Passive Extension Speaker Switch
- ⑰ Heat Sink
- ⑱ AC Power Cord Socket
- ⑲ DC Power Connector
- ⑳ Battery Compartment Cover Plate
- ㉑ Trolley Wheels

Portable Wireless PA System

Control Panel: Fig. 3

- ②② Digital Master Volume Control
- ②③ Master Volume Indicators
- ②④ Line Input Volume Control
- ②⑤ Line Input RCA Jack
- ②⑥ Line Output RCA Jack
- ②⑦ Voice over Music Priority Switch
- ②⑧ Bluetooth® Power Button & Indicator
- ②⑨ MIC 2: Unbalanced 6.3 Ø Microphone Input Volume Control
- ③⑩ Unbalanced 6.3 Ø Microphone Input
- ③① MIC 1: Balanced XLR Microphone Input Volume Control
- ③② Balanced XLR Microphone Input
- ③③ Tone Control.
- ③④ Echo Control on Microphones.

Portable Wireless PA System

II. Operating Instructions

1. Power On

Minimize all volume levels before turning on the Master Power Switch 12 . A fully lit Battery Status Indicators 13 indicates the rechargeable battery is fully charged. A single red color indicator indicates the rechargeable battery is low on power. Simply plug the supplied power cord into the power socket on the back and the other end into an AC power outlet to recharge the battery.

2. Master Volume Control

- (A) Master Volume Control 22 has two switchable modes. The standard mode resets to zero volume level after power is turned off. The memory mode saves and recalls the last programmed volume level by pressing and holding the specific volume indicator before power is turned off. Master Volume Indicators 23 displays the volume levels.
- (B) We recommend the master volume control is turned to the maximum level. Next, adjust volume of other audio input individually to avoid distortion with maximum dynamic range output. Built-in audio limiter serves automatically to prevent the signal level from exceeding a preset limit and stop sound from distorting.

3. Line-input 25 and Line-output 26 RCA Jacks

- (A) Reduce the Line Input 24 volume levels to minimum. Once powered on, adjust master volume levels 22 to maximum, and adjust line input volume to appropriate level.
- (B) Line Output jack 26 combines all mixed audio. Volume levels are individually adjusted, and not related to master volume control.

4. Wired Microphone

- (A) Reduce microphone volume levels to minimum. Once powered on, adjust master volume levels 22 to maximum.
- (B) Plug an unbalanced 6.3 Ø microphone into Unbalanced 6.3 Ø Microphone Input 30 and adjust MIC 2: Unbalanced 6.3 Ø Microphone Input Volume Control 29 .
- (C) Plug a balanced XLR microphone into Balanced XLR Microphone Input 32 and adjust MIC 1: Balanced XLR Microphone Volume Control 31 .
- (D) Tone Control 33 for high/low or Echo Control 34 effect adjustments.

Portable Wireless PA System

- (E) The Voice over Music Priority **27** feature mutes the volume of the played audio when it is switched to on and microphone is used. Feature is disabled if it is switched to off.
- (F) The wired and wireless microphones can be used at the same time and sound can be heard simultaneously.

5. Wireless Microphones

- (A) Reduce microphone volume levels to minimum. Once powered on, adjust master volume levels **22** to maximum.
- (B) Power on the receiver module and reduce volume levels to minimum.
- (C) Perform the channel synchronization between the receiver and transmitter by pressing the Channel sync ACT button. Once channel is synchronized adjust to the desired volume levels.
- (D) Both wired and wireless microphone has the voice over music priority function.

6. Pairing Bluetooth® Receiver

- (A) Power on the Bluetooth receiver and bring the mobile device within reception range.
- (B) Press & hold the Bluetooth power button & indicator **23** for 3-5 seconds until blue/red indicator **28** light is flashing intermittently to indicate the receiver is now ready to be paired.
- (C) If indicator is not flashing intermittently or not flashing, repeat by press & hold for 3~5 seconds until blue/red indicator is flashing intermittently.
- (D) Search Bluetooth devices and click on “MIPRO MB-xx” for receiver ID. Enter “0000” when prompted to enter a PIN code. This will cause your device to pair with the Bluetooth receiver.
- (E) Once paired and connection is made, the blue color indicator light on the Bluetooth receiver will continue to flash intermittently.
- (F) To cancel Bluetooth function by press & hold Bluetooth power button & indicator for 3 seconds.
- (G) Power off and on the Bluetooth receiver for changing connected device. Repeat the directions in “Pairing Bluetooth® Receiver” to connect a different device.
- (H) Pairing Bluetooth® for two devices:
Turn on one device first and operate steps A~E, then turn on the other one and do step B. Press the Bluetooth button twice for each device, during blue/red indicator light flashing intermittently, two Bluetooth receivers are pairing with each other. Once paired, the blue color indicator light will flash intermittently or stay on. Now play the music from the paired smartphone and get stereo sound amplification.

Portable Wireless PA System

7. This system can be hand-carried, dragged and set up on a speaker tripod. Fig. 4

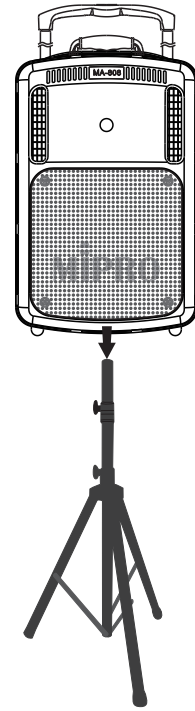

Fig. 4: MA-808 set up on a tripod

III. Connection for External Audio Sources. Fig. 5

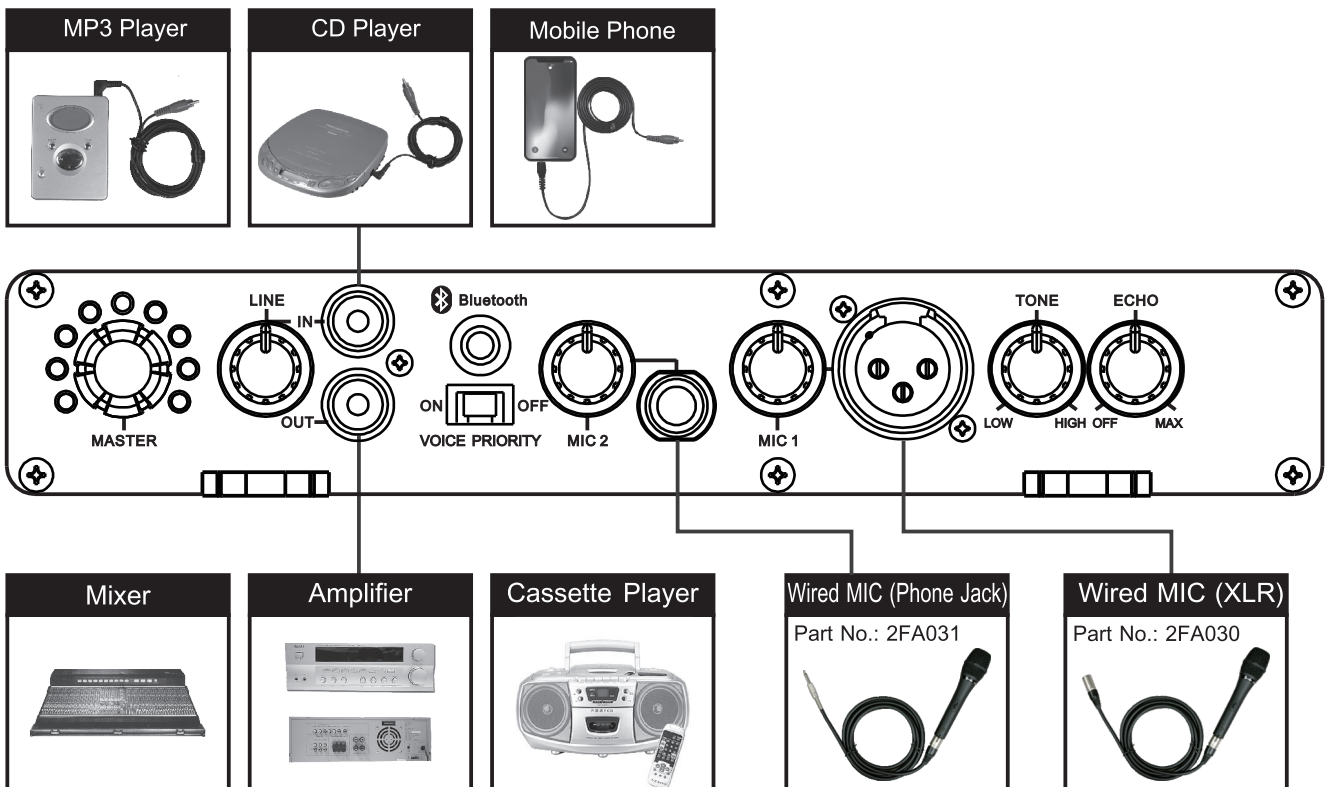

Fig. 5

Portable Wireless PA System

IV. Operation of Microphone Storage Compartment, Fig. 6

1. Two handheld transmitter microphones can be stored in the storage.
2. Storing Transmitters:
 - (A) Open the lid. (see fig. **A** & **B**)
 - (B) Place the microphone downwards with microphone head pointing up. (see fig. **C** & **D**)
 - (C) Once inserted, cover up the lid snugly. (see fig. **E** & **F**)

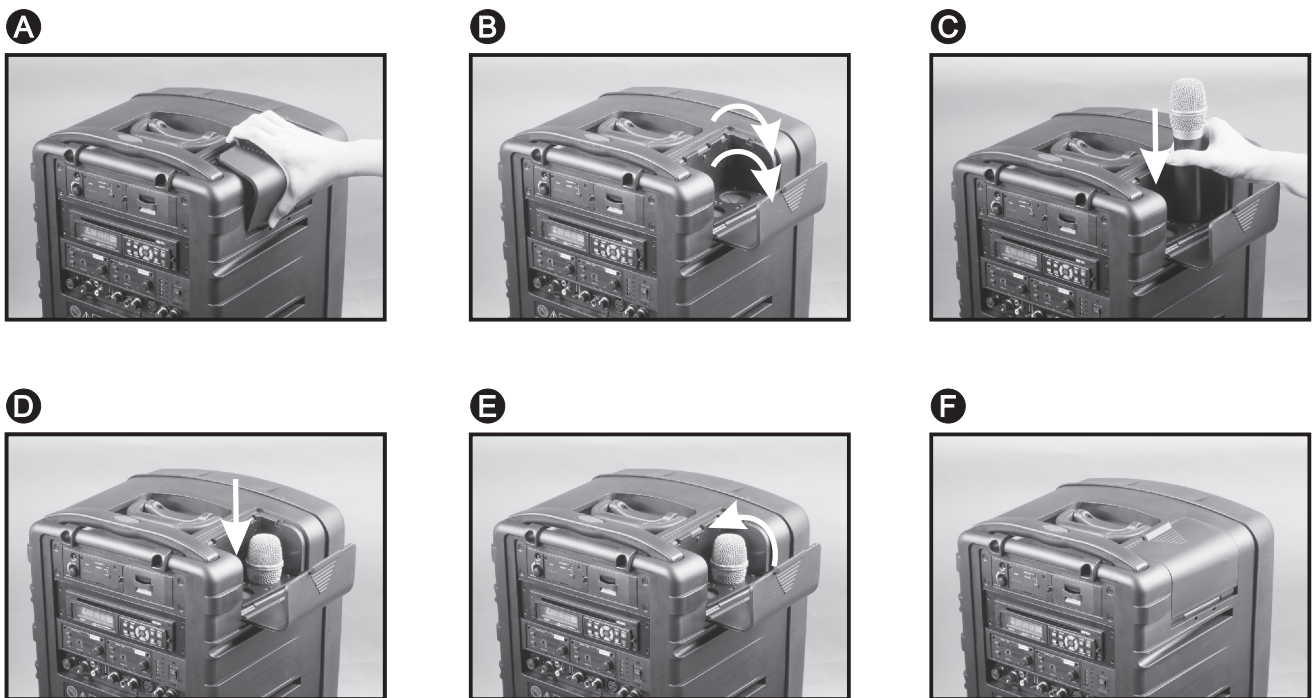

Fig. 6

Portable Wireless PA System

V. Replace Battery. Fig. 7

1. Remove screws from steel protection cover plate ⑳ by using a Phillips-head screwdriver (not supplied). Fig. 7-1
2. Tilt slightly, gently & slowly slide battery away from each battery housing compartment. Remove both color-coded wires. Fig. 7-2
3. Connect red-color wire and black-color wire (Fig. 7-3, 7-4). Ensure the red color cable is positioned on top, near the “+” terminal. Connect a 3rd cable (red color) to the terminal socket only for Left Side Compartment when replacing with MB-80.
4. Insert connected battery into left and right compartment. Fasten the screws once it is covered by steel protection cover plate. Fig. 7-5

* Note: Each MB-80 battery case holds 4 LFP batteries. 2 MB-80 battery cases are needed.

Fig. 7-1

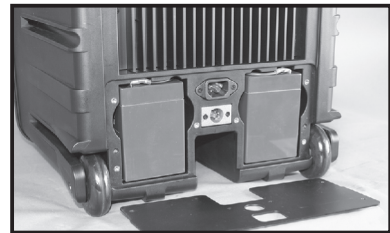
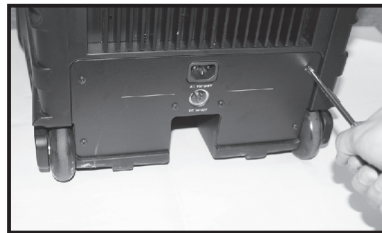

Fig. 7-2

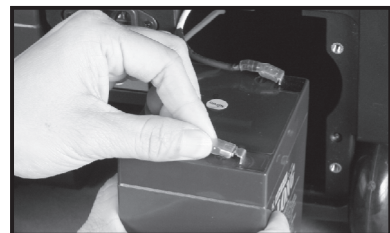

Fig. 7-3
Left Side
Compartment

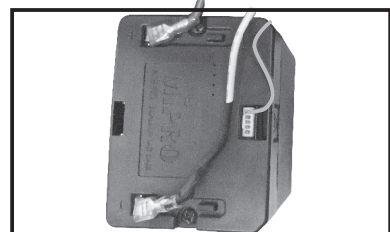
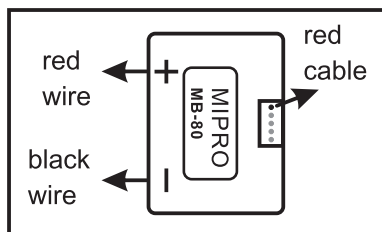
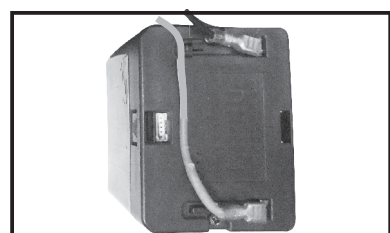
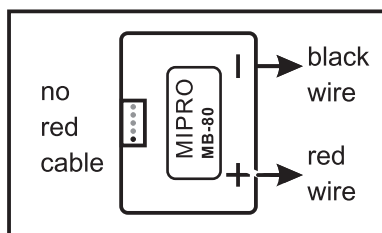

Fig. 7-4
Right Side
Compartment



Portable Wireless PA System

Fig. 7-5

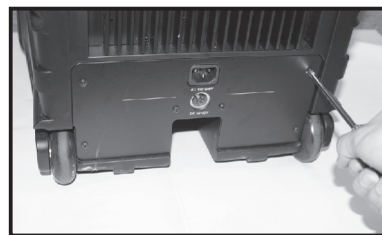

Fig. 7

5. Please only use the following rechargeable internal battery (MIPRO MB-70 x 2 or MB-80 x 2) or an equivalent rechargeable battery of the same type, rating & specifications when it is required to be replaced.

Manufacturer

Kung Long Batteries Industrial Co., Ltd.

Cat No

WP4.5-12

Rating

12 Vdc, 4.5 Ah

6.  CAUTION:

- (A) Always change both rechargeable batteries at the same time.
- (B) Do not mix battery types and do not mix old and new batteries. Replace both batteries at the same time.
- (C) Replace with the same type and rating rechargeable battery only.
- (D) Rechargeable battery can be purchased from authorized MIPRO distributors & dealers.
- (E) Danger of explosion if battery is incorrectly replaced.
- (F) Do not try to heat, ignite, disassemble or throw batteries into a fire.

Portable Wireless PA System

VI. Power Usage Instruction

1. How to use AC power input

- (A) After putting the power plug into the AC input socket ⑬ of the device, the 4 battery meter indicators ⑬ will glow immediately, no matter if the power switch is on or off. This means that the built-in switching power supply is functioning normally and the built-in rechargeable batteries are fully charged. If the battery meter indicators are blinking this means that the built-in switching power supply is working normally and the built-in rechargeable batteries are in an under charged condition. After a couple of minutes, the battery meter indicators will stop blinking and continue a glowing condition, indicating the batteries are now fully charged.
- (B) AC power provides power to both the unit itself and to the built-in lead-acid rechargeable batteries.
- (C) When using the AC power, you can remove or plug the power cord freely with no need to turn off the power switch first. If or when an unfortunate power cut happens during usage, the MA-808 will activate the DC power automatically to maintain continuous operation.

2. How to use DC power input

- (A) Two built-in series connection lead-acid batteries with models WP 4.5-12 are used. When the batteries are fully charged, the unit can be operated continuously for approximately 7~8 hours in standby mode (CD player and two receivers are turned on); 6~7 hours for audio and 5~6 hours for music. (The above figures are references for brand new batteries only)
- (B) The built-in rechargeable batteries can be recharged when the unit is plugged into an AC or DC power outlet.
- (C) In the case of no AC power connection, if the power switch ⑫ is not turned on, the battery meter indicators ⑬ will not be shining. When the power switch is turned on, the red LED on it will be shining; meanwhile, if 2 to 4 battery meter indicators are shining, it means the battery power is enough for normal operation. The number of the shining indicators is in direct proportion of the battery power. If only 1 battery meter indicator is shining or the red LED on the power switch is sparking, it means the battery power is insufficient and immediate charge is necessary. If no battery meter indicators are shining after the power switch is turned on, it means the batteries are completely discharged or possibly faulty.
- (D) Always store MA-808 system with the batteries fully charged if needing to store the system for more than 3 months. Leave the system plugged into an AC power outlet when not in use.

Portable Wireless PA System

- (E) The rechargeable batteries will not function properly if not recharged for an extended period of time. It is therefore, recommended to recharge after every use regardless of the usage time to preserve battery life.
- (F) If the battery is not used for a long time or not charged properly, even the storage temperature is too high, resulting in excessive discharge and charging failure, the first step is to remove the battery and charge it by 18V/2A DC power supply for more than half an hour and noted the battery surface temperature should not exceed 50 °C during charging. Then, reload it into the machine and turn on the power, if the battery indicator lights a red light, connect the AC power for normal charging procedure; if the battery indicator is completely off, which indicates that the battery has failed.



AC power and DC power can not be used at the same time.

A connector is included which allows users to make DC wiring.

See diagram below for illustration:

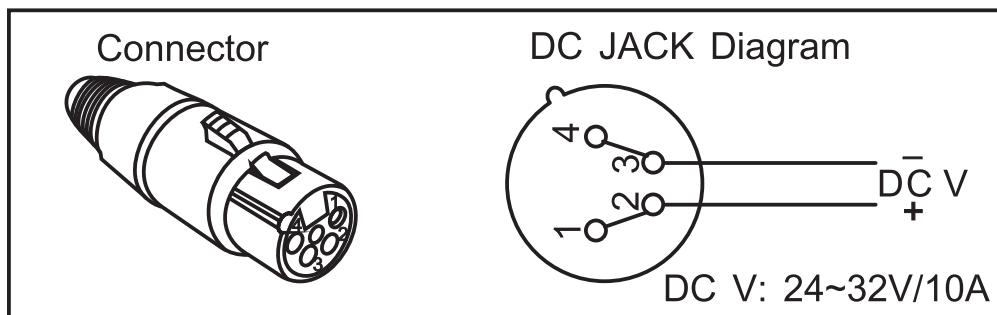

Fig. 8

Portable Wireless PA System

VII. Selection and Installation of Wireless Receiver Modules

1. Installation or replacement of wireless receiver modules. Fig. 9:

(A) Using a Phillips-head screwdriver (not supplied) remove the screws to remove receiver protection cover panel. (see figures A & B)

(B) Gently insert the receiver module into the slot. Make sure the back edge connector is aligned and firmly connected. (see figures C & D)

(C) Tighten up the screws. (see figure E)

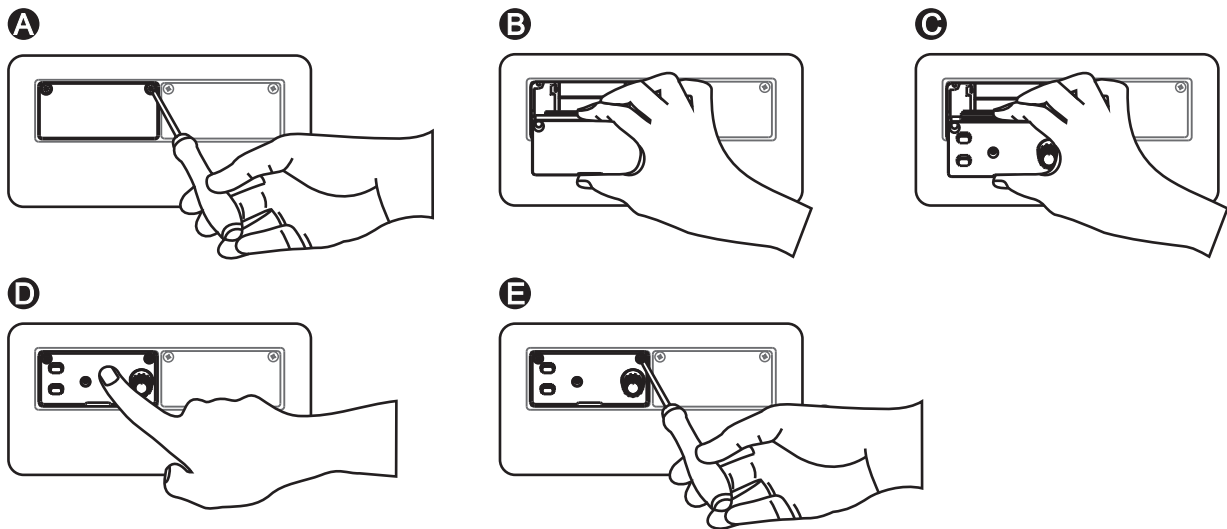

Fig. 9

2. To install wireless receiver modules, please refer to the user guide.

Portable Wireless PA System

VIII. Wireless Interlinking Transmitter and Receiver Modules

1. Users have options to add wireless interlinking transmitter module in this slot. Fig. 10

(A) Using a Phillips-head screwdriver (not supplied) remove the screws to remove protection cover panel.

(B) Insert the module slot frame in horizontal direction into the module trough, and tighten up the frame with the screws.

(C) Gently insert the transmitter module into the slot frame.

(D) Push a little harder to make sure the back edge connector is aligned and firmly connected. Tighten up the transmitter module panel with the screws.

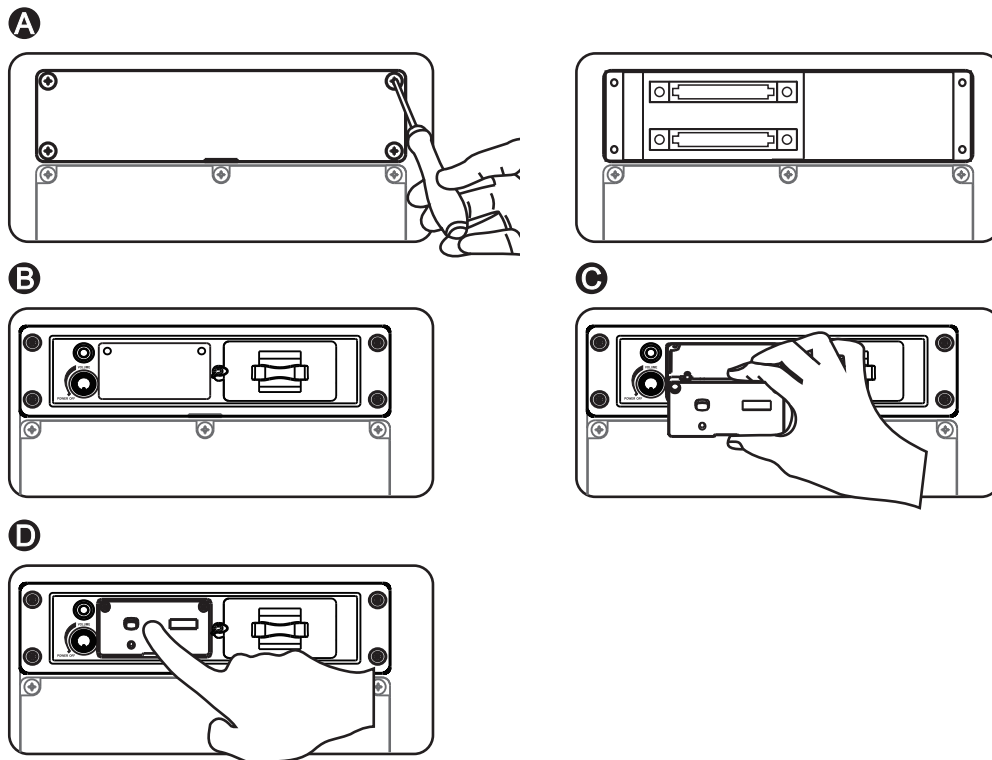

Fig. 10

2. To install Wireless Interlinking Transmitter, please refer to the user guide.

Portable Wireless PA System

IX. Installation of MIPRO CD/MP3 Media Player

1. Installation of CD/MP3 Media Player. Fig. 11

(A) Using a Phillips-head screwdriver (not supplied) remove the screws to remove protection cover panel.

(B) Gently insert the MP3 media player module into the slot. Make sure the back edge connector is aligned and firmly connected.

(C) Tighten up the screws.



Fig. 11

2. Operations of CD/MP3 Media Player: See a separate player manual enclosed in the master carton.

X. Helpful Operating Tips

1. Minimized the master volume control 22 before powering on. Adjust the volume controls afterward.
2. Each audio input is accepted through amplifier and its volume can be controlled separately.
3. Each audio input can be broadcasted and recorded at the same time.
4. NEVER place any wired or wireless microphone in front or close in front of the speaker otherwise feedback could occur.
5. Do not expose the MA-808 to an environment where there are water dropping or splashing.
6. Detached the power cord from AC power outlet once the system is fully-recharged.
7. Refer to operating instructions for wireless microphone system.
8. Refer to actual product in the event of product description discrepancy.
9. Frequency range, output power and maximum deviation to comply with the regulations of different countries.

MIPRO[®]
MICROPHONE PROFESSIONALS

MIPRO Electronics Co., Ltd
Headquarters: No. 814, Beigang Rd., Chiayi City 600079, Taiwan
Tel : +886.5.238.0809 Fax : +886.5.238.0803
www.mipro.com.tw mipro@mipro.com.tw

All rights reserved. YM 021/01

Do not copy or forward without prior approvals MIPRO.

Specifications and design subject to change without notice.



2005-08-18



2 CE538 E