

GEO S805

NEXO

geo S8

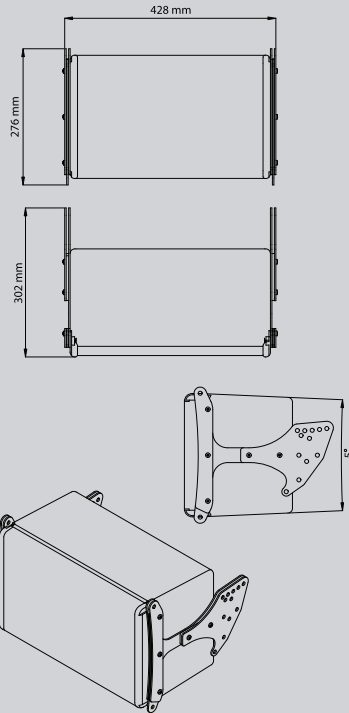

GEO S805 Advantages

- S805 is optimized for vertical tangent arrays.
- High power, long excursion neodymium 8" woofer delivers full range output from compact enclosures.
- Light weight (13kg per module including Array Assembly System) allows GEO tangent arrays to be hung almost anywhere.
- When vertically arrayed, multiple Hyperboloid Reflective Wavesources project tangent wavefronts from a common virtual source for coherent output.
- Configurable Directivity Device allows dispersion in the non-coupling plane to be changed from 80° to 120° through bolt-on flanges that alter the flare of the diffraction slot's exit.
- Directivity Phase Device combines enhanced line source coupling in vertical arrays with extended low frequency response.
- GEOSoft array design software predicts vertical tangent array performance for a wide range of venues.



The GEO S805 is compact, high-output array module designed for use in vertical tangent arrays. The Hyperboloid Reflective Wavesource allows multiple GEO S8 loudspeakers to radiate tangent wavefronts with coherent output.

The 5° wavesource is optimized for the construction of curved vertical arrays that deliver equal power to equal coverage areas for consistent SPL from front to rear of the audience area.

Advanced DSP algorithms, applied by the NX242 TDcontroller, precisely integrate GEO S systems with CD12 SubBass cabinets, so they may be flown together, without causing any interference between the GEO S and CD12 wavefronts.

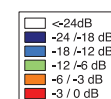
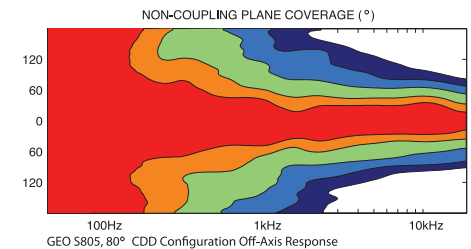
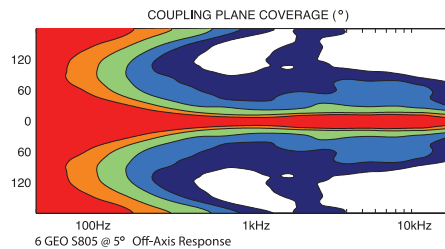

Geo S8



NEXO is one of the world's leading sound reinforcement loudspeaker manufacturers. Founded in 1979, the company is dedicated to crafting practical solutions with solid engineering. Each new design begins with a proprietary sophisticated computer simulation process that allows every parameter to be extensively modeled and simulated, leading to breakthrough cost and performance gains. NEXO's comprehensive product line includes loudspeakers, analogue and digital control electronics and amplification; all designed to deliver consistent sound quality and long term reliability for a broad range of applications.

NEXO S.A.
Parc d'Activité
du Pré de la Dame Jeanne
B.P. 5
60128 PLAILLY
Tel: +33 (0) 3 44 99 00 70
Fax: +33 (0) 3 44 99 00 30
e-mail: info@nexo.fr

NEXO LatAM
Tel: +1 305 677 9322
Fax: +1 360 234 7870
e-mail: info@nexo.fr

NEXO Asia
GPO Box 806
Hong Kong
SAR China
Tel: +852 9096 3472
Fax: +852 2104 3214
e-mail: info@nexo.fr

NEXO
www.nexo.fr

GEO S805 PRODUCT FEATURES

Components	LF 1x 8" (20cm) Neodymium Hi-flux 16Ω Driver HF: 1x 1" Throat Neodymium Driver on a Hyperboloid Reflective Wavesource
Height x Width x Depth	406 x 250 x 219mm (16" x 9 7/8" x 5 5/8")
Shape	5° Trapezoid
Weight	13kg (28.6lbs) net
Connectors	2x NL4MP 4-pole SPEAKON (In & Through)
Construction	Baltic Birch Ply finish with structured black coating. Dark grey carpet is optional.
Fittings	Grill Perforated Steel
Flying	Integral flying system. Intercabinet Angle Adjustments = 17.5° & 30°

SYSTEM SPECIFICATIONS GEO S805 WITH NX242 TDCONTROLLER

Frequency Response [a]	67Hz – 19kHz ± 3dB
Usable Range @-6dB [a]	60Hz – 20kHz
Sensitivity 1W @ 1m [b]	99dB SPL Nominal -97dB SPL Wideband
Peak SPL @ 1m [b]	Configuration dependent [d].
Dispersion [c]	Configuration dependent [d].
Non Coupling Plane	120° (configurable to 80°).
Directivity Index [c]	Not usable as a single cabinet. Configuration dependent [d].
Crossover Frequency	1.6kHz Passive
Nominal Impedance	16Ω
Recommended Amplifiers	1500 to 3000Watts into 4Ω / 4x cabinets per channel. Up to 6x cabinets per channel may be connected to large amplifiers capable of operating into low impedance loads.

SYSTEM OPERATION

Electronic Controller	The NX242 Digital TDcontroller presets are precisely matched to the GEO S8 Series cabinets and include sophisticated protection systems. Using GEO S8 Series cabinets without a properly-connected NX242 Digital TDcontroller will result in poor sound quality and can damage components. The GEO S805 & S830 can be used without the optional CD12 Hypercardioid Sub. In this case the NX242 can be used in stereo. With the CD12 Hypercardioid Sub, each Sub channel requires two NX242 outputs and the NX242 will operate in mono.
HF Dispersion Configuration	After release of the front grill from its fittings, the HF Waveguide can be configured for 80° or 120° dispersion in the non-coupling plane.
Array Design	S805 and S830 cabinets, having tangent waveguides, can be mixed in the same array. Minimum configuration for Vertical Tangent Arrays is 5x S805 & 1x S830 (4x S805 for paging applications only). CD12s are optional. A ratio of 1x CD12 per 3x full-range GEO modules is required for proper subbass output.
Speaker Cables	The GEO S805 and S830 are wired 1- & 1+ on both Speakon connectors, 2- & 2+ are not connected.
Rigging System	Please refer to the GEO User Manual before any operation.

SHIPPING & ORDERING

Packaging	S830s are packaged in pairs.
Shipping Weight & Volume	2x S830s: 29.2kg (64.2 lbs) 0.135 cu m (4.8 cu ft)

As part of a policy of continual improvement, NEXO reserves the right to change specifications without notice. [a] Response Curves and Data: Anechoic Far Field above 300Hz, Half-space below 300Hz. Usable Range Data: Frequency Response Capability with TD crossover slopes removed. [b] Sensitivity & Peak SPL: will depend on spectral distribution. Measured with band limited Pink Noise. Refers to the specified +/- 3dB range. Data are for Speaker + Processor + recommended amplifier combinations. [c] Directivity Curves and Data: 1/3 octave smoothed frequency response, normalized to On-Axis response. Data obtained by computer processing of off-axis response curves. [d] Please refer to the GEO User Manual.

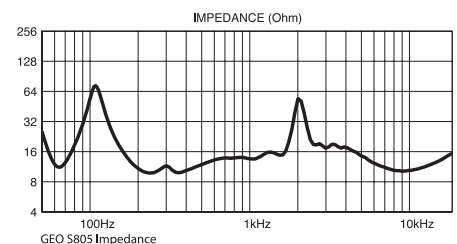
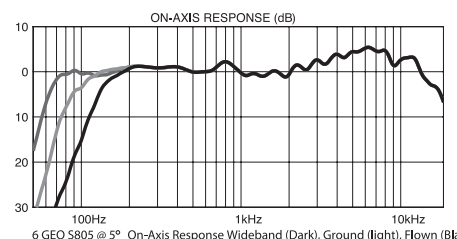

LIMITED WARRANTY

NEXO loudspeakers and electronics are covered against defects in workmanship or materials for a period of two (2) years from the original date of purchase. At the option of NEXO the defective item will be repaired/replaced with no charge for materials/labour. The item is to be adequately packaged and dispatched, pre-paid, to a NEXO authorised distributor/service centre. Unauthorised repair shall void the warranty. The NEXO warranty does not cover cosmetics or finish and does not apply to any items which in NEXO's opinion have failed due to used abuse, accidents, modifications or any type of misuse. All images and text herein are the property of NEXO SA, and deemed accurate, although specifications are subject to change without notice.

GEO S830

NEXO

Geo S8

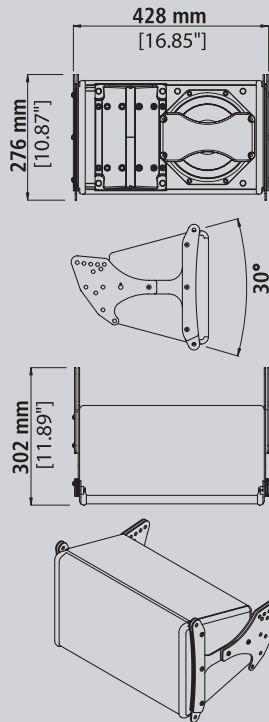

GEO S830 Advantages

- S830 can be deployed in horizontal or vertical tangent arrays.
- High power, long excursion neodymium 8" woofer delivers full range output from compact enclosures.
- Light weight (13kg per module including precision array assembly system) construction allows GEO tangent arrays to be hung almost anywhere.
- When vertically arrayed, multiple Hyperboloid Reflective Wavesources project tangent wavefronts from a common virtual source for coherent output.
- Configurable Directivity Device allows dispersion in the non-coupling plane to be changed from 80° to 120° through bolt-on flanges that alter the flare of the diffraction slot's exit.
- Directivity Phase Device combines enhanced line source coupling in vertical arrays with extended low frequency response.
- GEOsoft array design software predicts vertical tangent array performance for a wide range of venues.



The compact GEO S830 is a high-output array module intended for horizontal tangent arrays or as a downfill element in curved (tangent) vertical arrays to establish consistent SPL in all coverage areas. The HRW™ allows the 30° S830 and 5° S805 to be coherently arrayed together.

GEO S Series loudspeakers ship with 120° dispersion (in the non-coupling plane) Configurable Directivity Devices (CDD), but are field-changeable to 80° CDDs. To maximize down-fill coverage, CDFs are used on GEO S830s for the bottom two rows of curved vertical arrays.

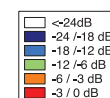
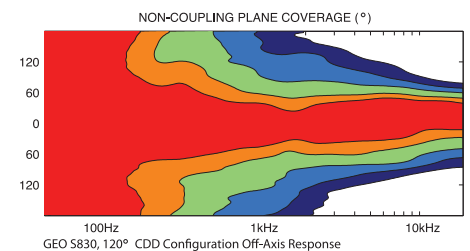
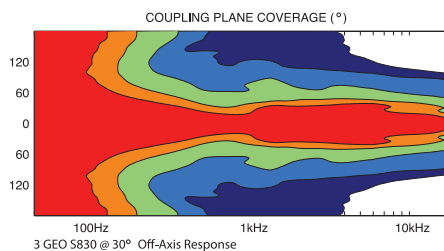

Geo S8



NEXO is one of the world's leading sound reinforcement loudspeaker manufacturers. Founded in 1979, the company is dedicated to crafting practical solutions with solid engineering. Each new design begins with a proprietary sophisticated computer simulation process that allows every parameter to be extensively modeled and simulated, leading to breakthrough cost and performance gains. NEXO's comprehensive product line includes loudspeakers, analogue and digital control electronics and amplification; all designed to deliver consistent sound quality and long term reliability for a broad range of applications.

NEXO S.A.
Parc d'Activité
du Pré de la Dame Jeanne
B.P. 5
60128 PLAILLY
Tel: +33 (0) 3 44 99 00 70
Fax: +33 (0) 3 44 99 00 30
e-mail: info@nexo.fr

NEXO LatAM
Tel: +1 305 677 9322
Fax: +1 360 234 7870
e-mail: info@nexo.fr

NEXO Asia
GPO Box 806
Hong Kong
SAR China
Tel: +852 9096 3472
Fax: +852 2104 3214
e-mail: info@nexo.fr

NEXO
www.nexo.fr

GEO S830 PRODUCT FEATURES

Components	LF 1x 8" (20cm) Neodymium Hi-flux 16Ω Driver HF: 1x 1" Throat Neodymium Driver on a Hyperboloid Reflective Wavesource
Height x Width x Depth	428 x 276 x 303mm (16 7/8" x 10 7/8" x 11 7/8")
Shape	30° Trapezoid
Weight	13kg (28.6lbs) net
Connectors	2x NL4MP 4-pole SPEAKON (In & Through)
Construction	Baltic Birch Ply finish with structured black coating. Dark grey carpet is optional.
Fittings	Grill Perforated Steel
Flying	Integral flying system. Intercabinet Angle Adjustments = .31° to 5° (logarithmic steps), 17.5° & 30°.

SYSTEM SPECIFICATIONS GEO S830 WITH NX242 TDCONTROLLER

Frequency Response [a]	67Hz – 19kHz ± 3dB
Usable Range @-6dB [a]	60Hz – 20kHz
Sensitivity 1W @ 1m [b]	99dB SPL Nominal -97dB SPL Wideband
Peak SPL @ 1m [b]	Configuration dependent [d].
Dispersion [c]	Coupling Plane: Not usable as a single cabinet. Configuration dependent [d].
Non-Coupling Plane	120° (configurable to 80°).
Crossover Frequency	1.6kHz Passive
Nominal Impedance	16Ω
Recommended Amplifiers	1500 to 3000Watts into 4Ω / 4x cabinets per channel. Up to 6x cabinets per channel may be connected to large amplifiers capable of operating into low impedance loads.

SYSTEM OPERATION

Electronic Controller	The NX242 Digital TDcontroller presets are precisely matched to the GEO S8 Series cabinets and include sophisticated protection systems. Using GEO S8 Series cabinets without a properly-connected NX242 Digital TDcontroller will result in poor sound quality and can damage components. The GEO S805 & S830 can be used without the optional CD12 Hypercardioid Sub. In this case the NX242 can be used in stereo. With the CD12 Hypercardioid Sub, each Sub channel requires two NX242 outputs and the NX242 will operate in mono.
HF Dispersion Configuration	After release of the front grill from its fittings, the HF Waveguide can be configured for 80° or 120° dispersion in the non-coupling plane.
Array Design	S805 and S830 cabinets, having tangent waveguides, can be mixed in the same array. Minimum configuration or Vertical Tangent Arrays is 5x S805 & 1x S830 (4x S805 for paging applications only). CD12s are optional. A ratio of 1x CD12 per 3x full-range GEO modules is required for proper subbass output.
Speaker Cables	The GEO S805 and S830 are wired 1- & 1+ on both Speakon connectors, 2- & 2+ are not connected.
Rigging System	Please refer to the GEO User Manual before any operation.

SHIPPING & ORDERING

Packaging	S805s are packaged in pairs.
Shipping Weight & Volume	2x S805s: 29.2kg (64.2 lbs) 0.135 cu m (4.8 cu ft)

As part of a policy of continual improvement, NEXO reserves the right to change specifications without notice. [a] Response Curves and Data: Anechoic Far Field above 300Hz, Half-space below 300Hz. Usable Range Data: Frequency Response Capability with TD crossover slopes removed. [b] Sensitivity & Peak SPL: will depend on spectral distribution. Measured with band limited Pink Noise. Refers to the specified +/- 3dB range. Data are for Speaker + Processor + recommended amplifier combinations. [c] Directivity Curves and Data: 1/3 octave smoothed frequency response, normalized to On-Axis response. Data obtained by computer processing of off-axis response curves. [d] Please refer to the GEO User Manual.

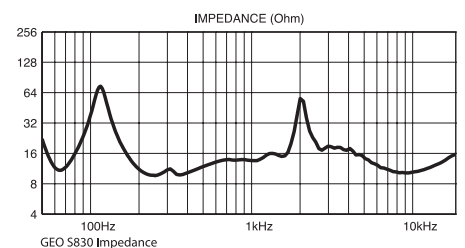
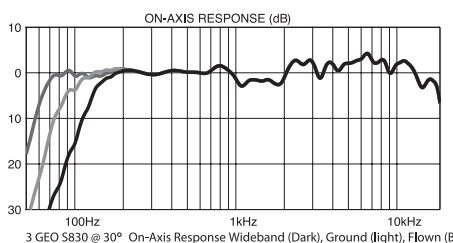

LIMITED WARRANTY

NEXO loudspeakers and electronics are covered against defects in workmanship or materials for a period of two (2) years from the original date of purchase. At the option of NEXO the defective item will be repaired/replaced with no charge for materials/labour. The item is to be adequately packaged and dispatched, pre-paid, to a NEXO authorised distributor/service centre. Unauthorised repair shall void the warranty. The NEXO warranty does not cover cosmetics or finish and does not apply to any items which in NEXO's opinion have failed due to used abuse, accidents, modifications or any type of misuse. All images and text herein are the property of NEXO SA, and deemed accurate, although specifications are subject to change without notice.