



© 2021 Cherub Technology-All rights reserved. No part of this publication may be reproduced in any form without prior written permission of Cherub Technology.

www.nuxefx.com Made in China

NUX

B-10 Vlog

2.4GHz Wireless Vlog System

Wireless Microphone

2.4GHz播客无线领夹麦克风



www.nuxefx.com

WARNING

To reduce the risk of fire or electric shock, do not expose this appliance to rain or moisture.

CAUTION

This device complies with part 15 of the FCC Rules. Operation is subject to the following two conditions: (1) this device may not cause harmful interference, and (2) this device must accept any interference received, including interference that may cause undesired operation. Any changes or modifications not expressly approved by the party responsible for compliance could void the user's authority to operate the equipment.

NOTE: This equipment has been tested and found to comply with the limits for a Class B digital device, pursuant to Part 15 of the FCC Rules. These limits are designed to provide reasonable protection against harmful interference in a residential installation. This equipment generates, uses and can radiate radio frequency energy and, if not installed and used in accordance with the instructions, may cause harmful interference to radio communications. However, there is no guarantee that interference will not occur in a particular installation.

If this equipment does cause harmful interference to radio or television reception, which can be determined by turning the equipment off and on, the user is encouraged to try to correct the interference by one or more of the following measures:

- Reorient or relocate the receiving antenna.
- Increase the separation between the equipment and receiver.
- Connect the equipment into an outlet on a circuit different from that to which the receiver is connected.
- Consult the dealer or an experienced radio/TV technician for help.

To maintain compliance with FCC's RF Exposure guidelines, The device has been evaluated to meet general RF exposure requirement. The device can be used in portable exposure condition without restriction. Use only the supplied antenna.



The lightning symbol within a triangle means, "Electrical caution!" It indicates the presence of information about operating voltage and potential risks of electrical shock.



The exclamation point within a triangle means, "Caution!" Please read the information next to all caution signs.

System Overview

NUX B-10 Vlog wireless Vlog system with automatic setup, 2.4 GHz interference-free broadcasting frequency, and 24-bit 44.1 kHz high-quality audio transmitting. The signal latency is super low and less than 5 ms. The operation range is around 30 meters (90-feet). It's a super light-weight wireless, mini-compact designed clip & go. The TX features a built-in omnidirectional electret microphone sending clear, broadcaster-grade audio via 2.4GHz digital transmission to the on-camera RX. The additional hot-shoe mount can stack 2 RXs on the camera, so you can use 2 B-10 Vlog systems for interview. (We offer a Y-cable for 2 vs 2 application.)

Note: While you use 2 B-10 Vlog systems, please turn on 1 set firstly, while it get paired, then turn on the other set.

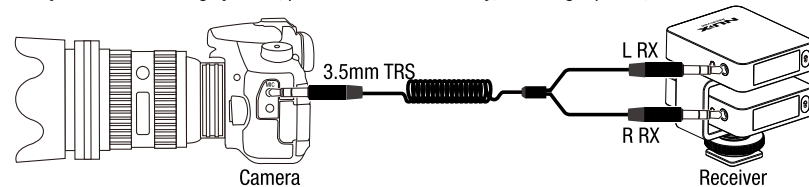

The user-friendly matching system makes it easy to use, just turn ON both wireless units (TX & RX), then it will be paired within a couple of seconds. Each wireless set has a unique pairing algorithm, it automatically detects each other and configures their own IDs. The signal never interferes with any other wireless including the WIFI* signal.

* Recommended: Please stay 2 meters (6 feet) away from the WIFI router for the best performance.

How to Operate

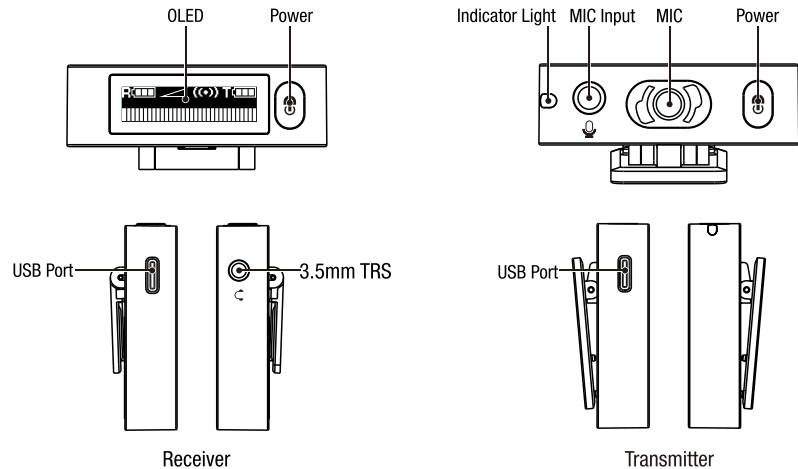

How to Operate

-Push and hold the power button for 2.5 seconds to turn ON the TX and RX.

-Before it gets paired automatically, you can see TX's battery status; if the LED indicator:

- Blinks GREEN – Well Charged (100% > GREEN ≥ 75%)
- Blinks YELLOW – Medium Battery (75% > YELLOW ≥ 50%)
- Blinks RED – Lower Battery (50% > RED ≥ 25%)
- Flashing RED for 10 times – Low Battery (<25%), turn off automatically to protect battery life.

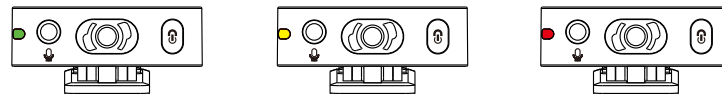

● LED  100% ≥ Battery ≥ 75%

● LED  75% > Battery ≥ 50%

● LED  50% > Battery ≥ 25%

● LED  Battery < 25%

* Regularly B-10 Vlog could work around 4 hrs since full-charged to low battery.

How to Operate

After 2 seconds, it will be paired automatically, and the TX's LED status will blink GREEN.
(B-10 Vlog will detect the best channel in the 2.4GHz frequency band, if the transmitter and receiver get paired, TX's LED will show GREEN. If the RX doesn't receive a signal, the RX's display will flash ((•)) Since the RX receive the signal, the display will show ((••)) to present the current receiving signal strength.



Break off



Connected

How to Operate

Clip the TX as lavalier microphone to mic your voice. Clip on the supplied windshield if required. If desired, plug in a compatible external microphone and the TX will automatically switch the audio input.

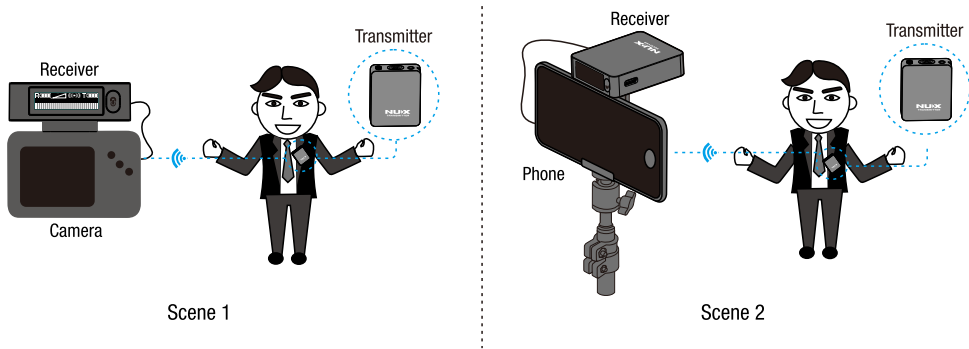

How to Operate

Since the TX is turned on. Short press TX's power button to switch MUTE(LED shows RED)/NORMAL(LED show GREEN) status. Since the RX is turned on, short press the power button to adjust OUTPUT LEVEL: 0dB / +6dB / +12dB / -12dB / -6dB sequentially. The default OUTPUT LEVEL is 0dB.

Please turn OFF both wireless units (the TX and the RX), and charge the wireless units directly by using the USB-C Y-cable (included). Once the unit is full charged, the charging function will be shut down automatically. During charging, the TX's LED shows RED while TX is off, TX's LED shows YELLOW while TX is on. During charging, the RX's display will show the current status.

NOTICE: To charge the B-10 Vlog, please make sure that your power adaptor has a power output of 5V and 1A (or higher).

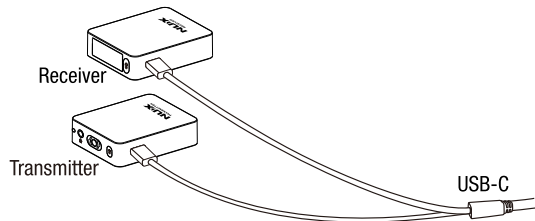

How to Operate

Manually ID repair

ID MATCH- B-10 Vlog already sets ID matched before shipping, but if you want to use a different transmitter or receiver to get paired, please follow the steps to re-set the ID match.

1. Turn of the TX & RX.
2. Hold the power button of the TX and RX for more than 8 seconds, then it will enter to ID match status.
3. Since the TX's LED shows GREEN, it finishes ID match and enter to normal work status.

NUX offers various of 2.4GHz wireless systems, you can use up to 6 systems simultaneously in one space. Please avoid using other wireless systems together with NUX ones, or there may be noise or interference issues.

Function Introduction

Mute function

While B-10 works, press the TX's power button once, it will enter to MUTE status, then the TX's LED will show RED, and the RX's display will show:

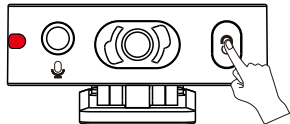
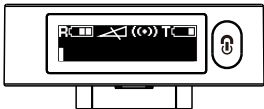

Press the TX's power button again, it will go back to NORMAL work status. The TX's LED will show GREEN. (If you use the TX during charging, the TX's LED will show YELLOW.)

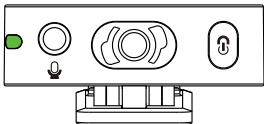

Normal work

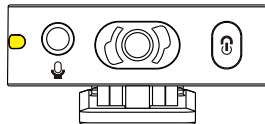

Work during charging

Specifications

- Operating Frequency Band: 2.4 GHz
- Operation Length: < 100 feet (30m)
- Sampling Rate: 24bit / 44.1 kHz
- Frequency response: 50Hz-20kHz
- Latency: < 5ms
- Dynamic Range: 96dB
- THD+ Noise: <0.2%@1kHz
- Built-in Battery Capacity (TX & RX): 400mAh/3.7V
- Maximum Input Level(3.5mm TRS): 100mVrms(-20dBV)

*Specifications and appearance subject to change without notice.

- Battery Running Time: 4 hours
- Microphone on TX: Omnidirectional Electret Condenser Microphone
- Maximum Sound Pressure Level: 110dB SPL
- Dimensions
TX/RX: 51mm(L) x 42mm(W) x 13mm(H)
- Weight
TX/RX: each 28g

Accessories: 1. Windshield 2. USB Y-cable 3. 3.5mm TRS(female) to TRRS(male) adaptor cable for Mobile Phone (CTIA stander) 4. 3.5mm TRS Cable for RX to Camera
5. 3.5mm TRS Y-cable for 2RXs to Camera.

产品简介

NUX B-10 Vlog是一款基于2.4GHz无线技术打造的播客无线领夹麦克风。它具有高音质（24bit/44.1kHz）低延迟（小于5ms）以及传输距离远（最远可达30m）等特点，可轻松应对Vlog和小型访谈等应用场景的实时收音任务。

B-10 Vlog的发射端内置了全指向驻极体话筒以及一个3.5mm音频输入接口，您可根据实际需要选用内置话筒或是外接领夹式麦克风；B-10 Vlog的接收端配备了一块高清显示屏，方便实时监测收音状态。发射端与接收端开机后片刻便自动完成配对并进入录音状态。此外，B-10 Vlog的发射端与接收端均内置了高性能锂电池，最长录音时间可达4小时。

除本体外，我们还提供了丰富的配件：冷靴接收端支架可同时安放两个B-10 Vlog 接收端，使用两套B-10 Vlog 时配合附赠的Y形音频线可让您从容完成一对一采访或主客体互动视频的收音任务；防风罩可以有效减少风噪以及呼吸声。

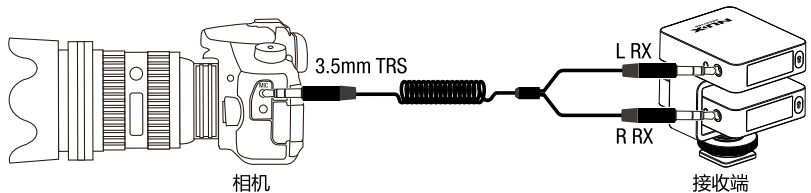

快速操作指南

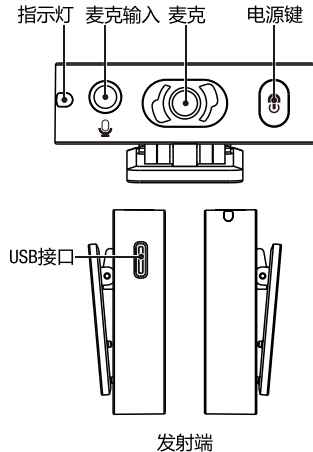
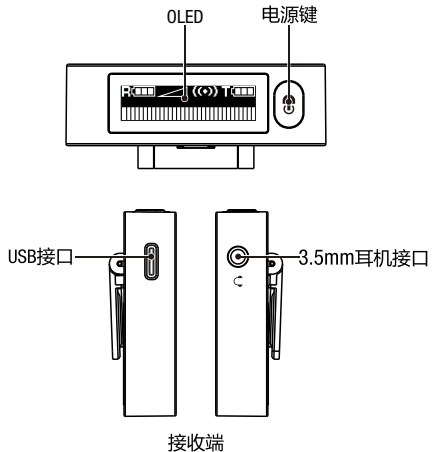

快速操作指南

按住发射端、接收端上的电源键约2.5秒，打开接收端以及发射端。

在自动配对完成前，您可以依据发射端上的指示灯颜色来判断发射端的电池电量：

- 闪烁绿色 - 电量充盈（电量大于等于75% 小于等于100%）
- 闪烁黄色 - 电量适中（电量大于等于50% 小于75%）
- 闪烁红色 - 电量偏低（电量大于等于25% 小于50%）
- 红色快速闪烁10次 - 电量极低（电量小于25%，即将自动关机）

大约2秒后，发射端与接收端会自动完成配对。

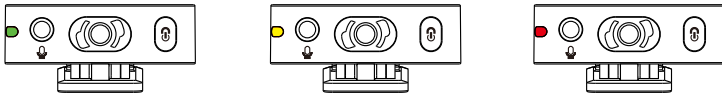

● LED  100% ≥ 电量 ≥ 75%

● LED  75% > 电量 ≥ 50%

● LED  50% > 电量 ≥ 25%

● LED  电量 < 25%

快速操作指南

B-10 Vlog 会自动扫描当前环境的2.4GHz信号并选用最佳频点完成配对，配对完成后发射端的指示灯保持绿色常亮状态。如果接收端未能接受到信号，接收端的显示屏上的“(•)”图标将持续闪烁；当接收端成功接收到发射端发出的信号，接收端显示屏上的“(••)”图标将显示当前连接信号的强弱。



断开



连接

快速操作指南

根据实际需要扣上防风罩或插入领夹话筒。当您使用外接领夹话筒时，发射端内置的话筒将停止工作。

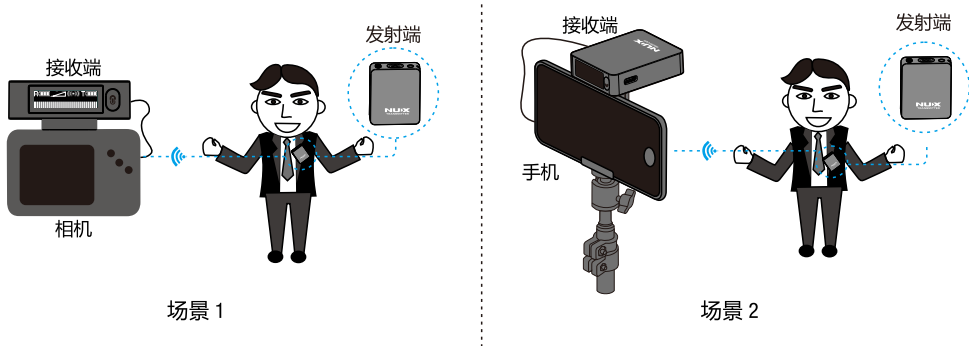

发射端开机后，您可以短按发射端上的电源键来切换发射端的工作模式：MUTE（静音）模式时，发射端的指示灯为红色；NORMAL（正常）模式时，发射端的指示灯为绿色。接收端开机后，您可以短按接收端的电源键来调整输出音量（-12dB / -6dB / 0dB / +6dB / +12dB），发射端默认的输出音量为0dB。

快速操作指南

为B-10 Vlog充电

当电池电量不足时，请及时为B-10 Vlog充电。充电前请确认发射端与接收端均处于关机状态，然后使用附赠的USB-C“Y”形充电线连接充电器为发射端和接收端充电。充电过程中发射端的指示灯会亮红色，充电完成后指示灯自动熄灭。接收端的显示屏在充电时会显示当前充电进度。

注意：只能使用5V充电器为B-10 Vlog充电；请确保充电器能输出至少1A的电流。如果在使用过程中发射端的电池电量不足，您可以使用移动电源一边给发射端充电一边继续使用发射端。边充电边使用时，发射端的指示灯会保持黄色常亮状态。

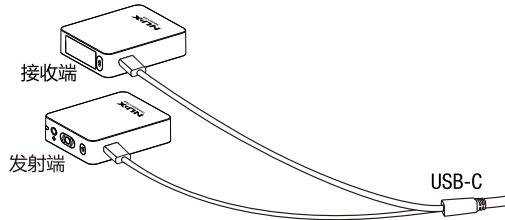

手动配对

B-10 Vlog在出厂前已经进行了一对一加密配对, 如果您想要重新配对或将接收端(发射端)与其它B-10 Vlog的发射端(接收端)配对使用, 请进行以下操作:

1. 将需要配对的接收端与发射端关机。
2. 同时按住接收端与发射端的电源键约8秒后接收端与发射端会重新配对。
3. 重新配对完成后, 发射端的指示灯会保持绿色常亮状态并进入正常录音模式。

注意: 为满足消费者的需求, 我们开发了多款2.4GHz无线系统产品, 同一空间内最多可同时使用6对NUX无线产品。为了避免出现噪声或窜扰问题, 请尽量避免将其它无线产品与NUX无线产品同时使用。

静音功能

B-10 Vlog 正常工作时, 您可以短按发射端上的电源键使发射端进入MUTE(静音)模式, 静音模式时发射端的指示灯为红色且接收端的显示屏上显示“”图标。

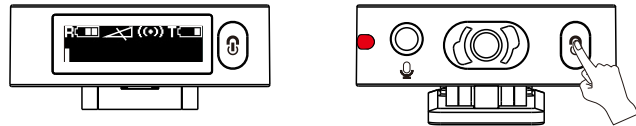

当发射端处于静音模式时, 再次短按发射端上的电源键即可退出静音模式, 此时发射端的指示灯变为绿色常亮状态。

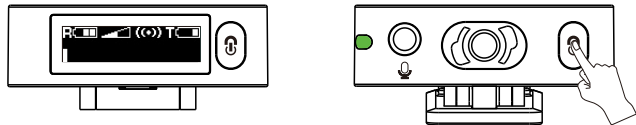

技术规格

- 工作频段：2.4GHz
- 有效工作距离：最远30米（视具体录音环境而定）
- 采样率：24bit/44.1kHz
- 频率响应：50Hz-20kHz
- 系统延迟：<5ms
- 动态范围：96dB
- 信号失真度：<0.2%@1kHz
- 电池容量：400mAh/3.7V(发射端与接收端)
- 最大输入电平（3.5mm TRS）：100mVrms（-20dBV）
- 使用时长：约4小时
- 内置麦克风：驻极体全指向电容麦克风
- 最大声压级：110dB SPL
- 发射端/接收端尺寸：51mm(L) x 42mm(W) x 13mm(H)
- 发射端/接收端重量：28g

*技术规格如有变更，恕不另行通知。

附件：

1. 防风罩
2. USB Y型充电线
3. 手机端3.5mm TRS（母座）转TRRS（公头）转接线（CTIA标准）
4. 3.5mm TRS线（接收端输出到相机录音输入口）
5. 3.5mm TRS Y型线（两个接收端输出到相机录音输入口）

有关产品中所含有害物质的说明

为了控制和减少电器电子产品废弃后对环境造成的污染，本资料就本公司产品中所含的特定有害物质及其安全性予以说明。
本资料适用于2016年7月1号以后本公司所制造的产品。

环保使用期限



此标志适用于在中国国内销售的电子信息产品，表示环保使用期限的年数。所谓环保使用期限是指在制造日起的规定期限内，产品中所含的有害物质不致引起环境污染，不会对人身、财产造成严重的不良影响。环保使用期限仅在遵照产品使用说明，正确使用产品的条件下才有效。不当的使用，将会导致有害物质泄漏的危险。

产品中有害物质的名称及含量

部件名称	有害物质					
	铅 (Pb)	汞 (Hg)	镉 (Cd)	六价铬 (Cr(VI))	多溴联苯 (PBB)	多溴二苯醚 (PBDE)
主体	塑胶件	○	○	○	○	○
	五金件	×	○	○	○	○
	硅胶件	○	○	○	○	○
	内置电路板	×	○	○	○	○
附件	*交流电源适配器、线缆					
	×	○	○	○	○	○

*表示某些产品可能不含有这些项目，上表当中的信息仅在产品含有这些项目时适用。

本表格依据SJ/T 11364的规定编制。

○：表示该有害物质在该部件所有均质材料中的含量均在GB/T 26572规定的限量要求以下。

×：表示该有害物质至少在该部件的某一均质材料中的含量超出GB/T 26572规定的限量要求，因根据现有的技术水平，还没有什么物质能够代替它。

保护环境

如果需要废弃本产品，请遵循本地相关指引，请勿随意丢弃或作为生活垃圾处理，以避免对环境造成污染。

质量承诺

亲爱的 **NUX** 用户：

在您使用 **NUX** 产品时，请仔细阅读产品说明书，当您有疑问和困难时，请拨打售后服务热线：**400-990-9866**

■一周内出现质量问题可退货退款 ■一月内出现质量问题可调换 ■一年内出现质量问题可免费维修 ■终身享有咨询和维修服务

[请向销售商索取正规发票并予以保存]

换修政策

一、包换政策：

1、消费者通过正规授权渠道购买的产品，自购机之日起1个月之内，在正常使用情况下出现非人为的产品性能故障、且产品外观及包装保持完好，可向所购机的经销商换机。

2、消费者在换机时应出示由经销商开出的购机凭证，否则经销商可以不予更换。

二、保修政策：

1、消费者通过正规授权渠道购买的产品(以发票所示销售方为准)，自购买之日起1年内，若出现非人为损坏的性能故障，可享受有免费维修服务。

2、对于超过1年或人为及不可抗力因素造成损坏的产品，我司可提供有偿维修服务。

*本售后政策仅适用于中国大陆地区，其它国家及地区以当地售后政策及法律法规为准。

合格证

检验员 名称 2.4GHz播客无线领夹麦克风

生产日期 型号 B-10 Vlog

本产品经检验合格
执行标准: Q/WKDZ 001-2020

售后服务地址

广东省珠海市高新区唐家湾镇科技九路10号
珠海市蔚科科技开发有限公司 售后服务部
邮编：519085

制造商: 深圳市蔚科电子科技有限公司 制造商地址: 深圳市南山区蛇口兴华路6号南海意库1栋507

电话：0755-2686 9866 网址：cn.nuxefx.com

生产商: 珠海市蔚科科技开发有限公司

生产商地址: 珠海市高新区唐家湾镇科技九路10号 电话：0756-3689866

执行标准: Q/WKDZ 001-2020